

OWNER'S MANUAL

EGOS - Q/S/B



TABLE OF CONTENTS

1.	Features	3
2.	Technical Specifications	3
3.	Installation	
	3a. Flooded Batteries	4
	3b. VRLA Batteries	10
4.	Visual LED & Audio Alarms Indications	15
5.	Connectivity	
	5a. eGO!Receiver	16
	5b. eGO!Cloudlink	20
	5c. eGO!Gateway	23
6.	Frequently Ask Questions (FAQs)	26



eGO!Plus FlexiTap (Q) Flooded
Model no. EGOS-24QE



eGO!Plus M4 (S) Flooded
Model no. EGOS-24SE



eGO!Plus M10 (B) Flooded
Model no. EGOS-24BE



eGO!Plus FlexiTap (Q) VRLA
Model no. EGOS-24QG



eGO!Plus M4 (S) VRLA
Model no. EGOS-24SG



eGO!Plus M10 (B) VRLA
Model no. EGOS-24BG

SECTION 1: FEATURES

- eGO!Plus™ Battery Performance Monitor can be installed on multiple battery types
- Super bright LED indicators
- Audio alert indicators
- Multiple connection types
- Small and slim fit
- Simple to use
- Easy to install
- Only-on-charge data transfer with less background interference

SECTION 2: TECHNICAL SPECIFICATIONS

Table 1: Technical Specifications

	EGOS-24QE	EGOS-24SE	EGOS-24BE	EGOS-24QG	EGOS-24SG	EGOS-24BG
Battery Technology	Flooded Batteries			VRLA Batteries		
Connection Types	FlexiTap (Q), M4 Screw (S), M10 Bolt (B)					
Fuses	FlexiTap (Q): 1 x Board, 2 x In-connector M4 Screw (S): 1 x Board, 2 x In-connector M10 Bolt (B): 1 x Board, 2 x In-connector					
Operating Voltage	24V-80V Nominal (12V, 72V & 120V Optional)					
Max Current	200-24mA @ 24-80V (Radio transmitting)					
Nominal Current	100-13mA @ 24-80V (Radio not transmitting)					
Temperature Monitoring	Internal sensor					
LED Indications	Green: Electrolyte OK Red: Fill Now Amber: Over Temperature Blue: Comms Operating			Green: Operating OK Amber: Over Temperature Blue: Comms Operating		
Reversible Power Connection	Yes					
Over-discharge Threshold	80%					
Flame Retardant	Yes					
Data Storage	Cycle data					
Data Collection	Via eGO!CloudLink / eGO!Receiver & eGO!Tools Webapp / eGO!Gateway / eGO!Tools App (Android)					
Cable Colour (s)	Yellow (-), Yellow (+), Blue (Probe)			Yellow (-), Yellow (+)		
Physical Dimensions	150 mm (L) x 44 mm (W) x 25 mm (H) / 5.91 in (L) x 1.73 in (W) x 0.98 in (H)					
Weight	140g (Flooded) 114g (VRLA)					
Warranty	2 Years					

FLOODED BATTERIES



The eGO!Plus™ Battery Performance Monitor is intended for use on 24V to 80V (12V, 72V & 120V Optional) Flooded batteries.

The eGO!Plus™ Battery Performance Monitor monitors and records cycles, temperatures and manually upload or automatically sends this data to a gateway or app for visualisation online.

It provides LED indications for electrolyte status, overtemperature and communication. If the status of the battery is OK and the device is working OK, it will flash green.

SECTION 3A: INSTALLATION - FLOODED BATTERIES (CONT'D)

TOOLS REQUIRED

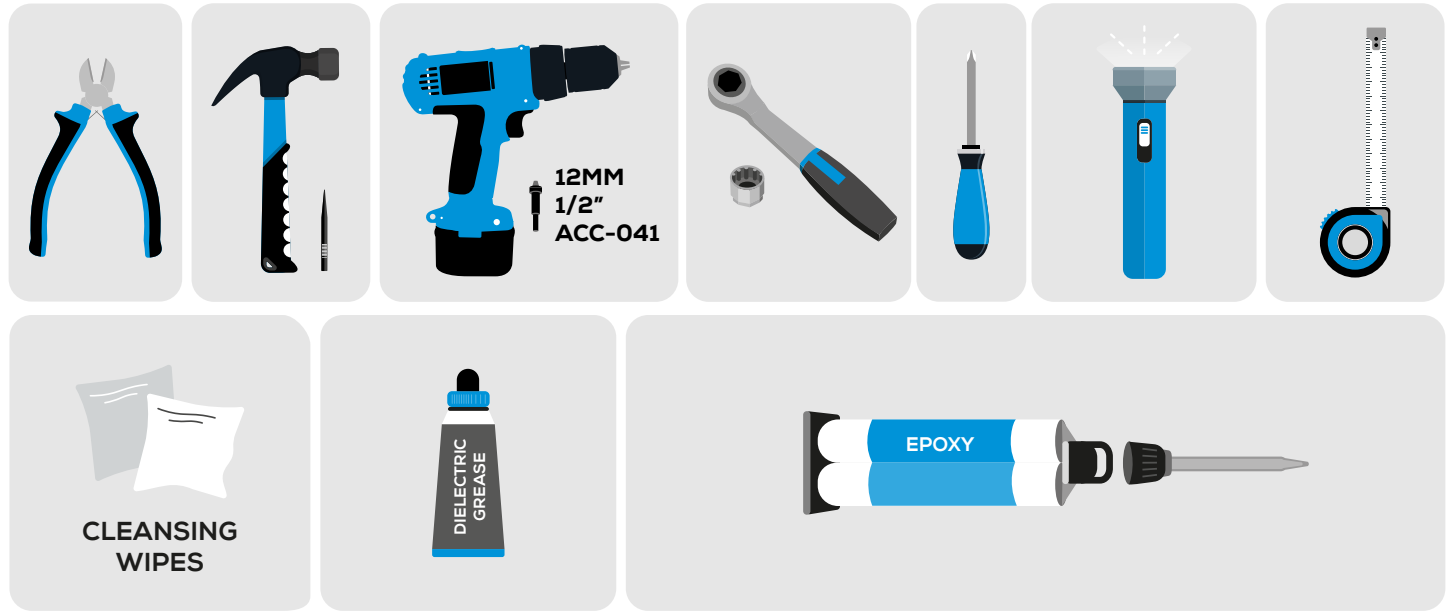

SAMPLE CELLS LAYOUT

Figure 1: eGO!Plus Battery Performance Monitor Final Assembly on 24V Flooded Batteries

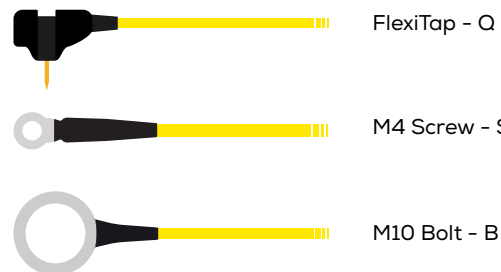
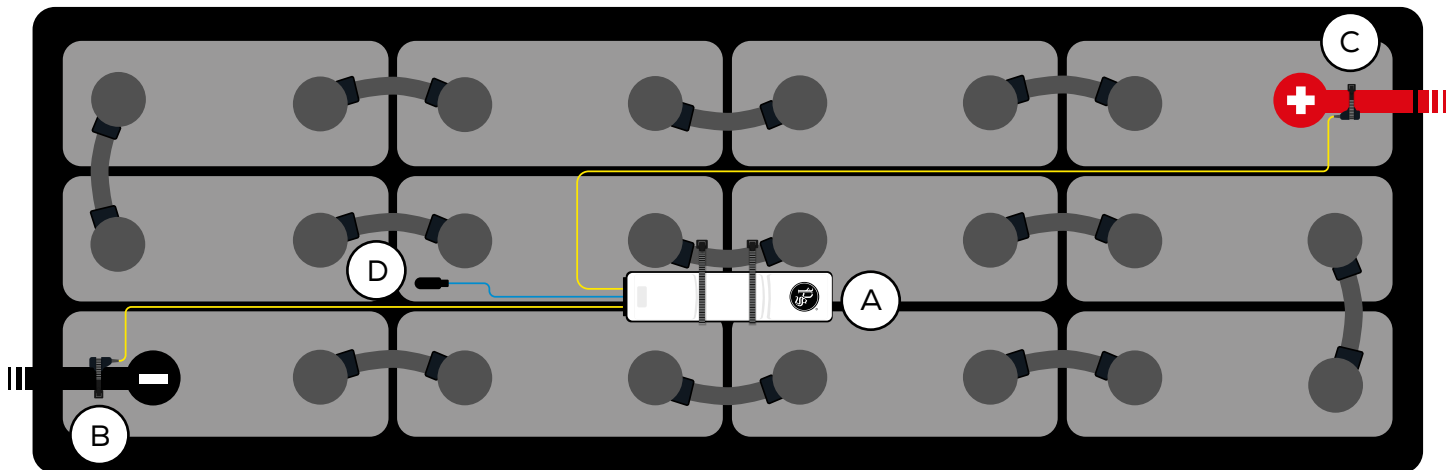

(A) eGO!Plus Battery Performance Monitor

(B) (C) Connection - Q / S / B



(D) Electrolyte Probe

SECTION 3A: INSTALLATION - FLOODED BATTERIES (CONT'D)

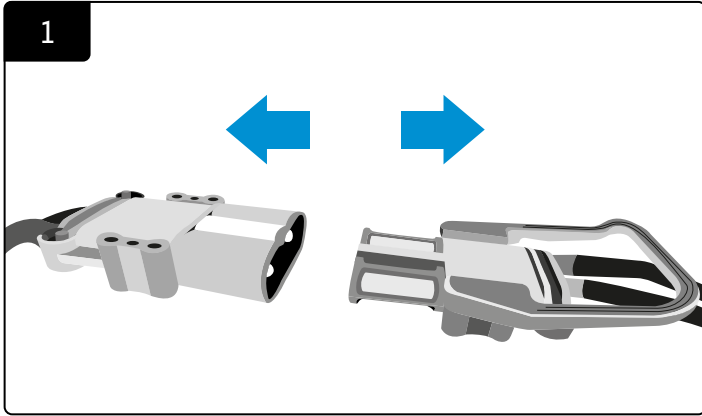

1
Disconnect the power connection before installation.

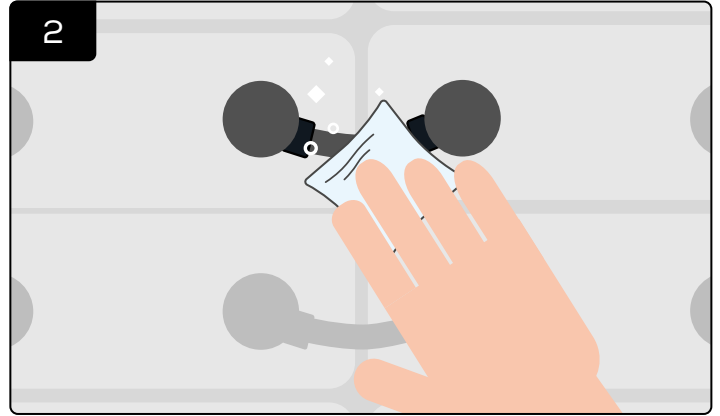

2
Clean and wipe the battery before installation.
***Ensure the surface is completely dry.**
Cleaning not required on new batteries.

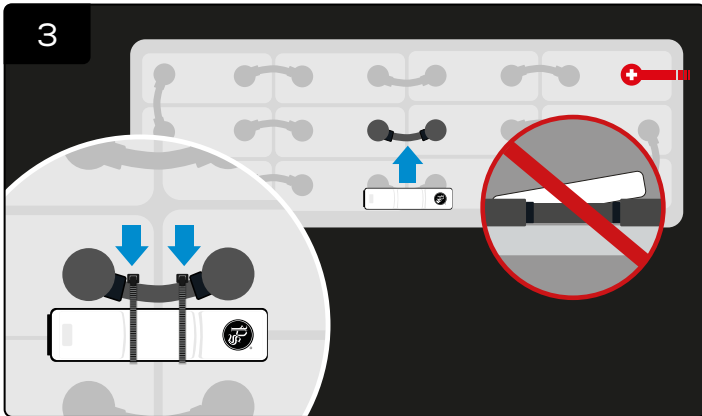

3
Attach the eGO!Plus battery performance monitor to the battery and secure it with cable ties.
***Ensure it is positioned flat on the battery to allow the temperature sensor functions properly.**

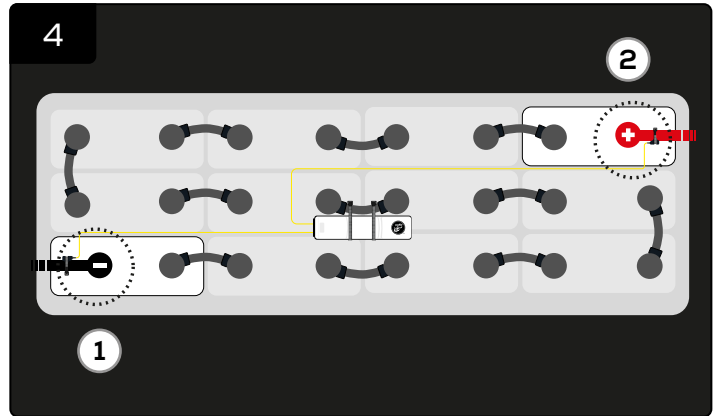

4
Connect the two yellow cables to the negative terminal, then positive terminal.
***Note: Once the terminal connections are connected, the initial start-up will begin as below.**

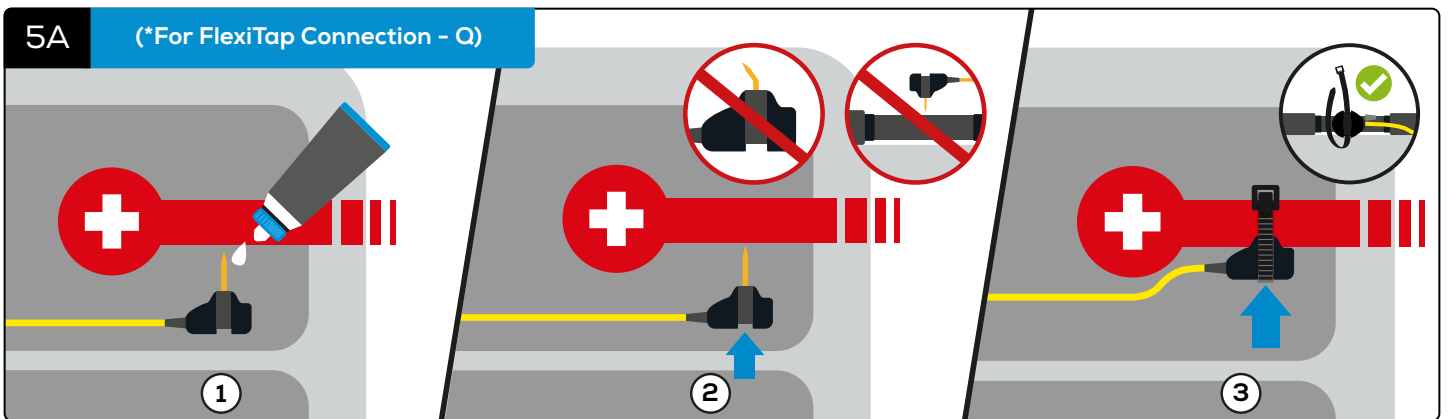

5A (*For FlexiTap Connection - Q)

Apply the grease on the pin. Insert the FlexiTap into the centre of the cable from the side, to ensure a good connection and secure it with a cable tie.
***Make sure it is positioned in the centre of the cable from the side, taking care not to bend the pin.**

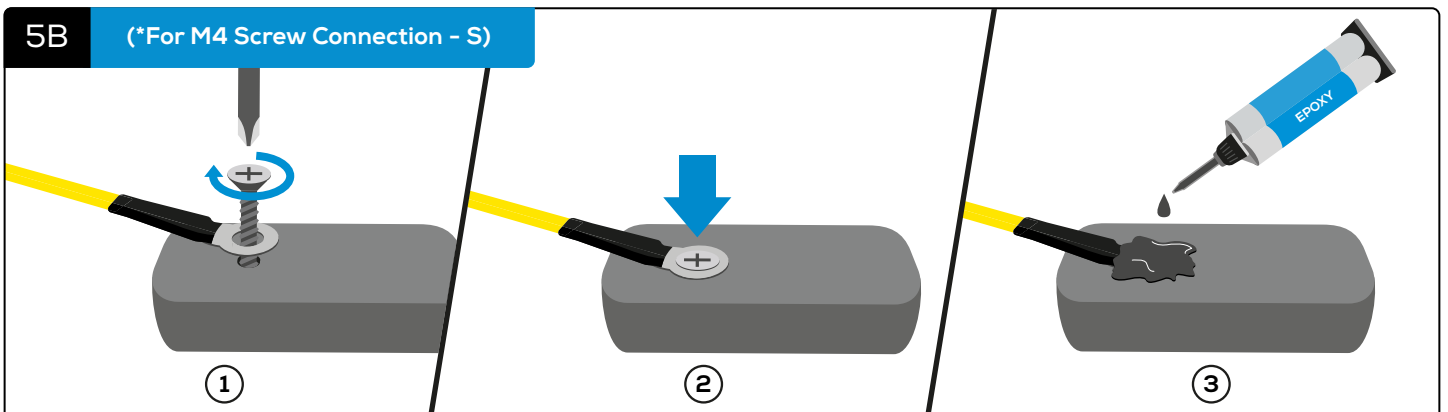

5B (*For M4 Screw Connection - S)

Screw the M4 connection to the terminal, make sure it is firmly attached to the battery. And apply epoxy on top of the screw.

SECTION 3A: INSTALLATION - FLOODED BATTERIES (CONT'D)

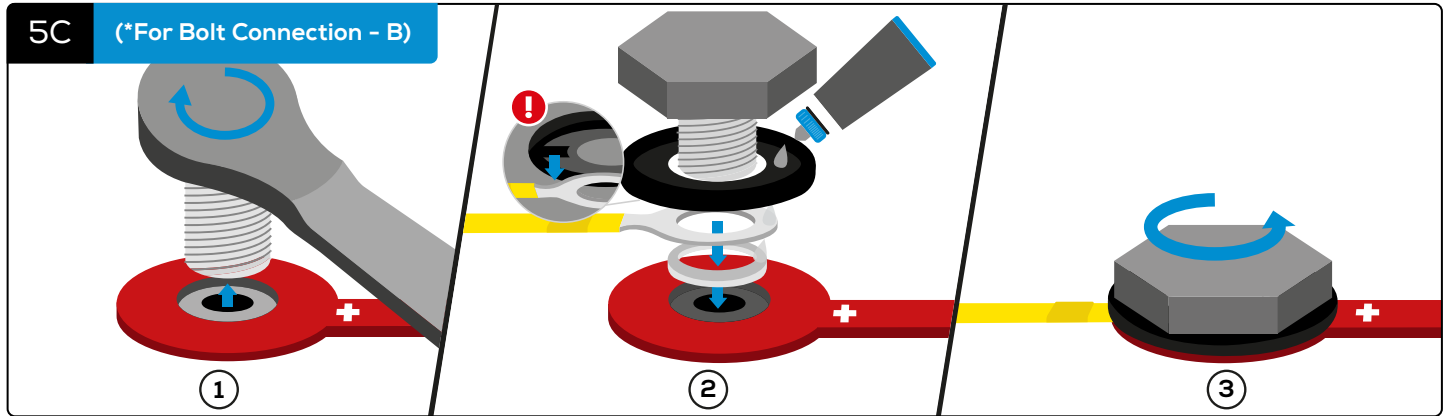

Remove the terminal bolt. Apply a thin layer of grease to the washer, the ring of bolt connection and the rubber gasket, then place them in the corresponding order. Ensure the bolt connection align to the rubber gasket and it is firmly attached to the terminal.

(*Note: Tighten the bolt to manufacturer-recommended torque settings.)

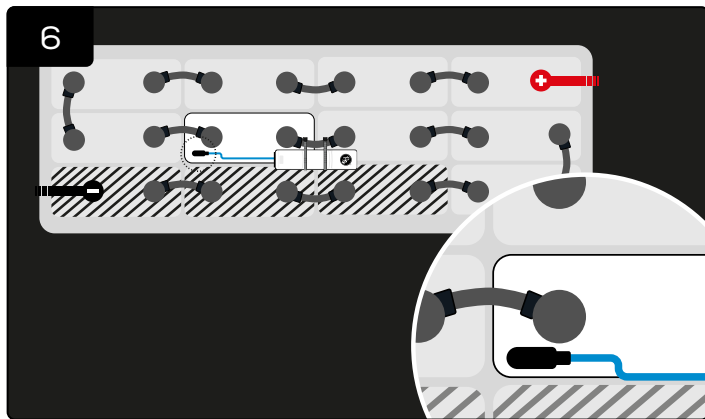

Install the electrolyte probe.

*Probe can be installed in any cells **apart from the first three cells** from the negative battery terminal.

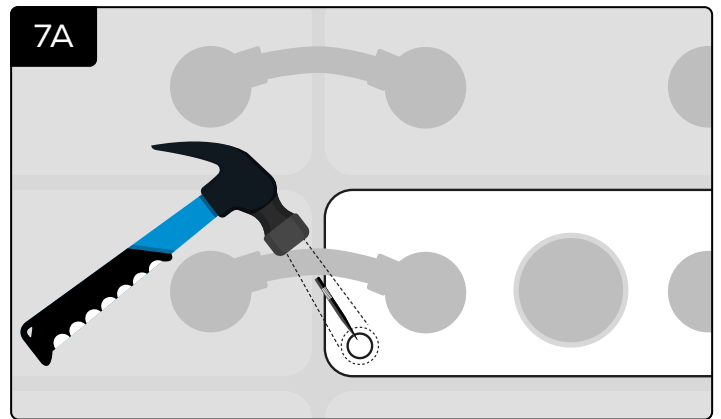

Punch a hole.

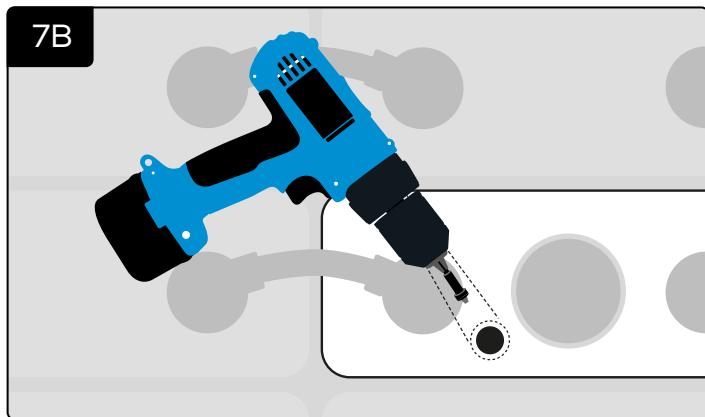

OR drill a hole.

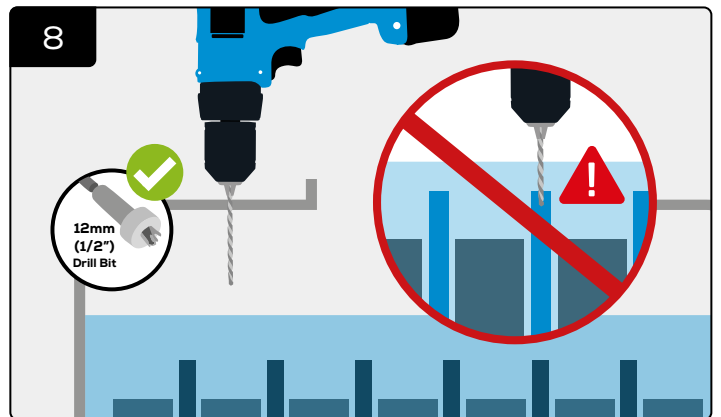

Make sure the drill does not touch the electrolyte and the plates.

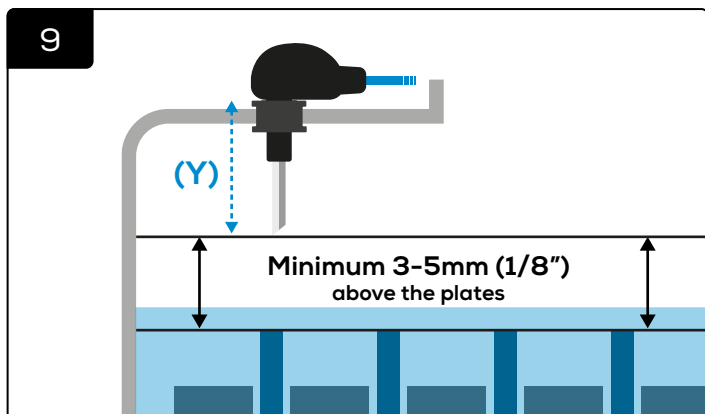

Measure the length of the probe (Y).

*Make sure it is at least 3-5mm (1/8 inch) above the plates.

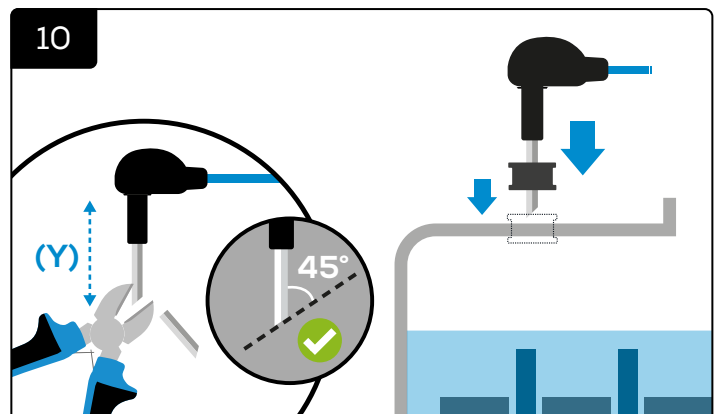

Trim the probe to the correct length (Y), **cut at 45 degree angle** as needed, and insert it into the battery with the grommet in place.

Once the power has been connected, check **the start-up LED sequence**.

SECTION 3A: INSTALLATION - FLOODED BATTERIES (CONT'D)

INITIAL START UP

Once the power connections have been made and the electrolyte level indicator has been correctly installed along with the current clamp, the eGO!Plus is ready to start monitoring. Once the positive and negative connections have been made you should expect to see the following light sequence:

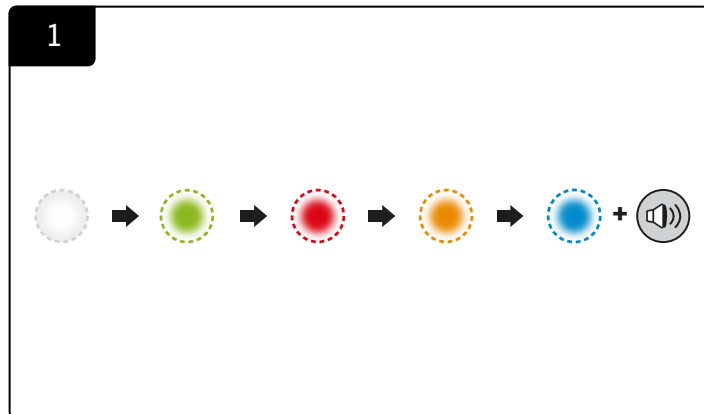

Starting main application.



Internal storage initializing.

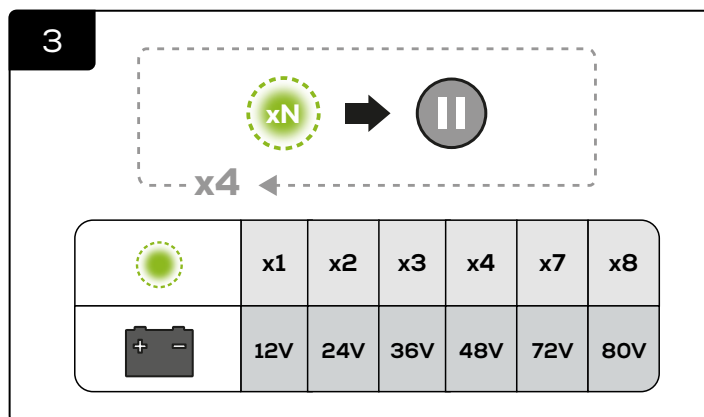

A number of green flashes followed by a pause is repeated four times. The flashes indicate different battery voltages detected.

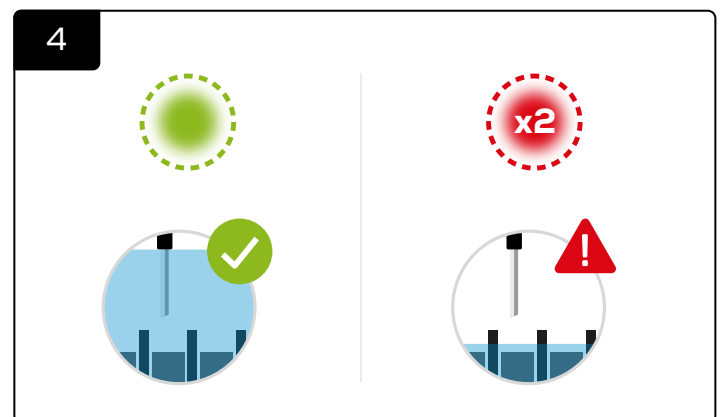

Green lights slowly pulsing indicate optimal operation, or if the electrolyte level is low, it will double flash red.

(*For LED indications, please refer to [Figure 3.](#))

SECTION 3A: INSTALLATION - FLOODED BATTERIES (CONT'D)

AUTOMATIC UPLOAD

When the battery is fully charged, the eGO!Plus will automatically trigger upload and will start flashing blue for 20 seconds. If there is an internet connected eGO!CloudLink installed in the battery room, it will send the data to batterymanagement.net

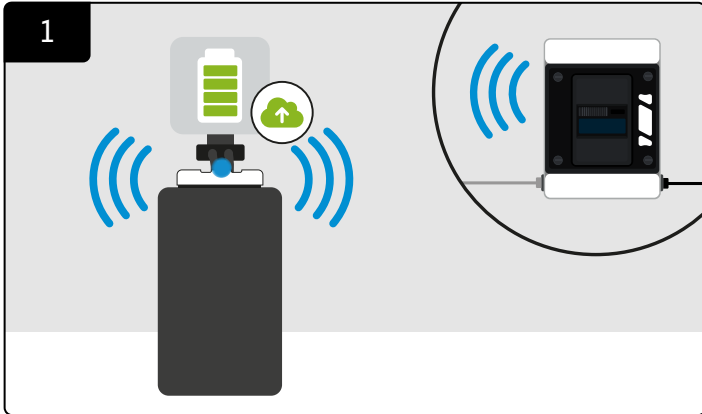

The blue LED will start flashing to indicate an automatic data upload via eGO!CloudLink to batterymanagement.net when the battery is fully charged.



When the upload is completed, eGO!Plus will return to its normal state of flashing green (or red if the electrolyte level is low)

The eGO! Data is now available on batterymanagement.net.

MANUAL UPLOAD

eGO! data is accessible at any time, even when the battery is not fully charged. You can trigger data uploads using the CloudLink feature in the eGO!Tools app.

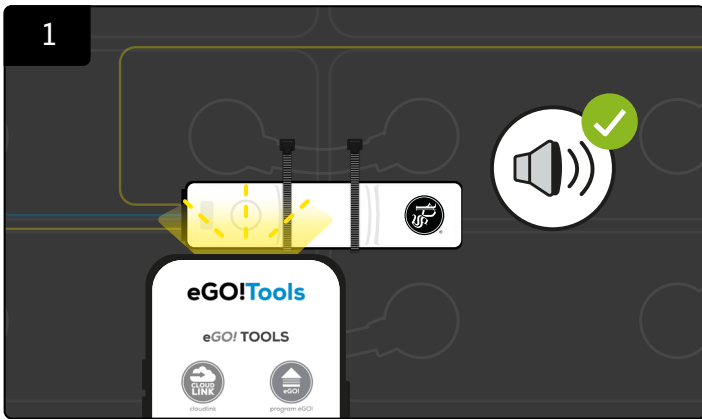

Click 'CloudLink' in the eGO!Tools app.

Take a bright flash light (*A mobile phone flash light will be adequate) and place directly on **top of the white circle on eGO!Plus**, until you hear a beep along with blue LED.

(*Note: A flash light may not work under very bright sunlight. You must shade the unit for at least 5 seconds, then use the light source to activate the manual upload.)

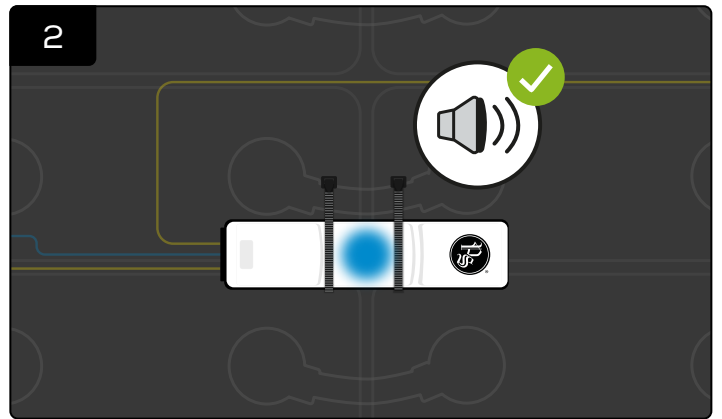

At this point quickly remove the flash light and you should hear a second beep.

*If the second beep is not heard, then the sequence will need repeating, allowing for a 3-second reset period before the next attempt.

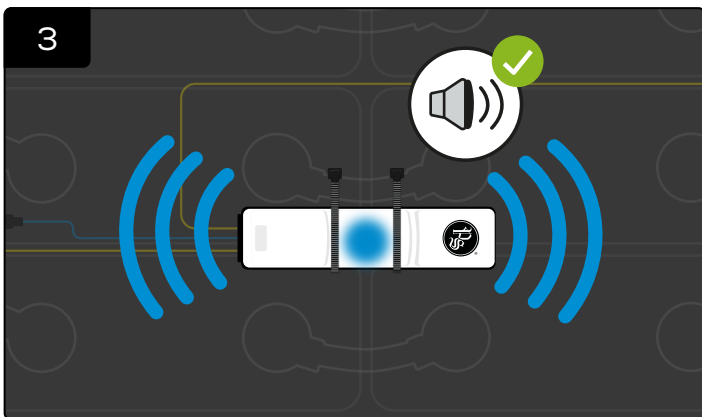

The radio is now enabled, and the blue LED remains illuminated until all data has been transmitted.

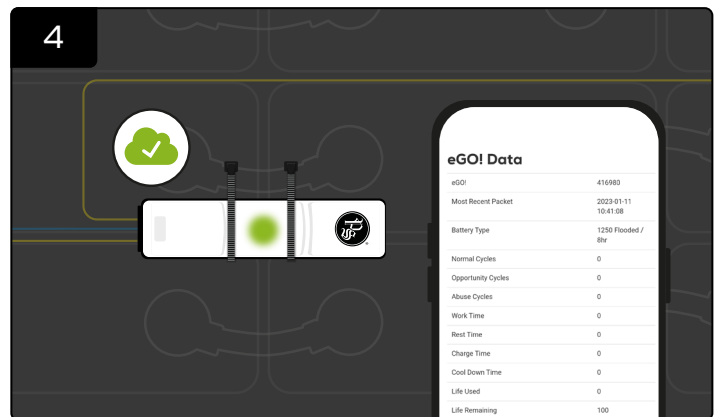

When the upload is completed, eGO!Plus will return to its normal state of flashing green (or red if the electrolyte level is low)

The eGO! Data is now available in eGO!Tools app.

VRLA BATTERIES



The eGO!Plus™ Battery Performance Monitor provides is intended for use on 24V to 80V (12V, 72V & 120V Optional) VRLA batteries.

The eGO!Plus™ Battery Performance Monitor monitors and records cycles, temperatures and manually upload or automatically sends this data to a gateway or app for visualisation online.

It provides LED indications for overtemperature and communication. If the status of the battery is OK and the device is working OK, it will flash green.

SECTION 3B: INSTALLATION - VRLA BATTERIES (CONT'D)

TOOLS REQUIRED

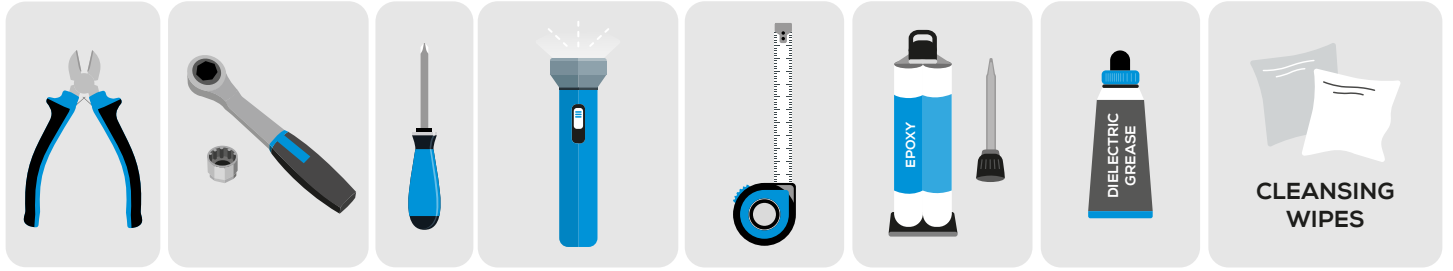

SAMPLE CELLS LAYOUT

Figure 2: eGO!Plus Battery Performance Monitor Final Assembly on 24V VRLA Batteries

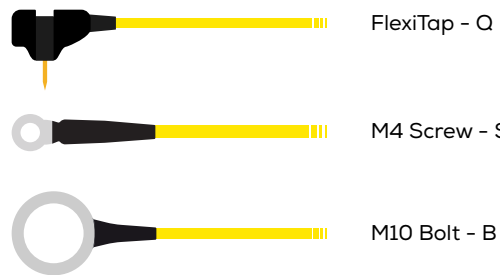
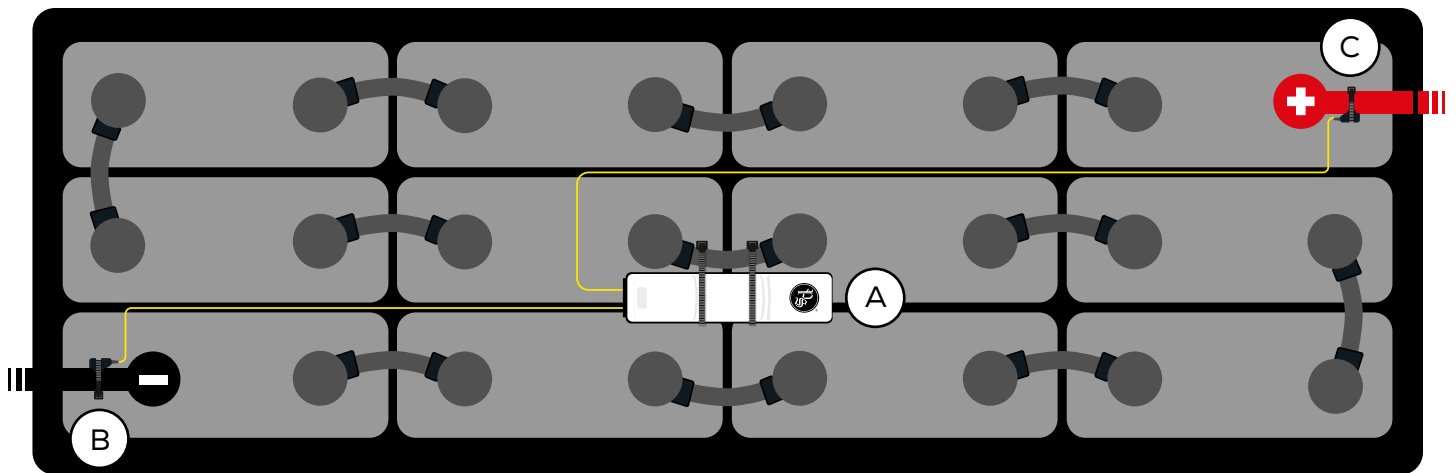

(A) eGO!Plus Battery Performance Monitor

(B) (C) Connection - Q / S / B

SECTION 3B: INSTALLATION - VRLA BATTERIES (CONT'D)

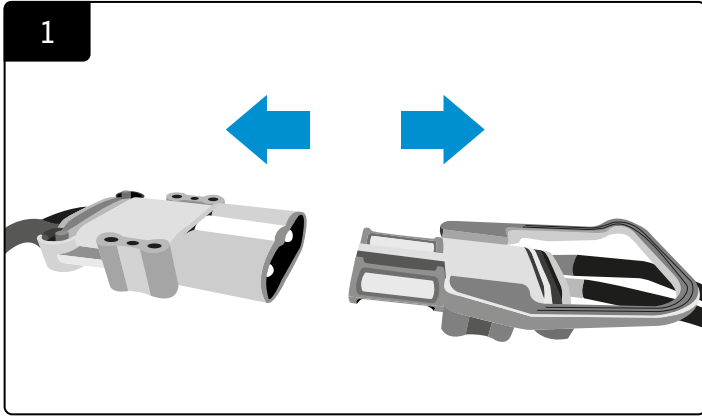

1
Disconnect the power connection before installation.

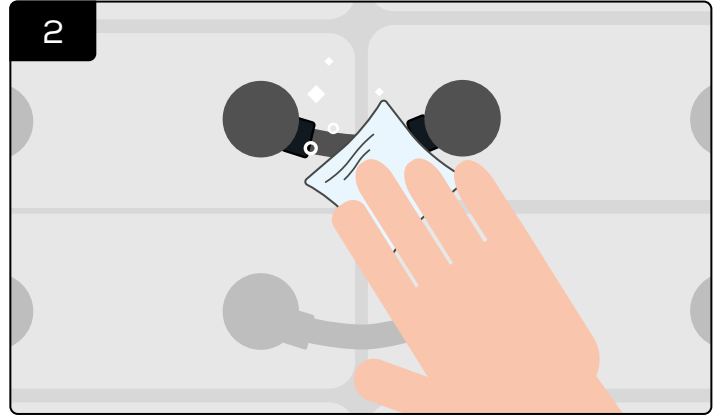

2
Clean and wipe the battery before installation.
***Ensure the surface is completely dry.**
Cleaning not required on new batteries.

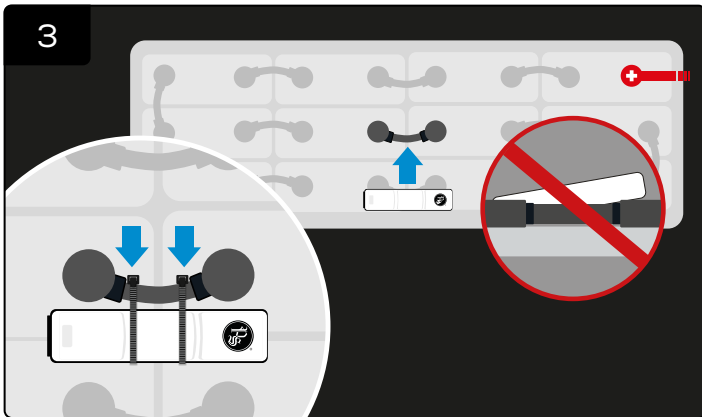

3
Attach the eGO!Plus battery performance monitor to the battery and secure it with cable ties.
***Ensure it is positioned flat on the battery to allow the temperature sensor functions properly.**

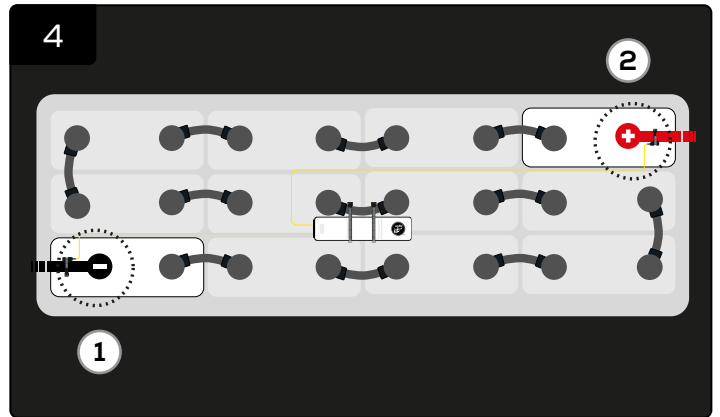

4
Connect the two yellow cables to the negative terminal, then positive terminal.
***Note: Once the terminal connections are connected, the initial start-up will begin as below.**

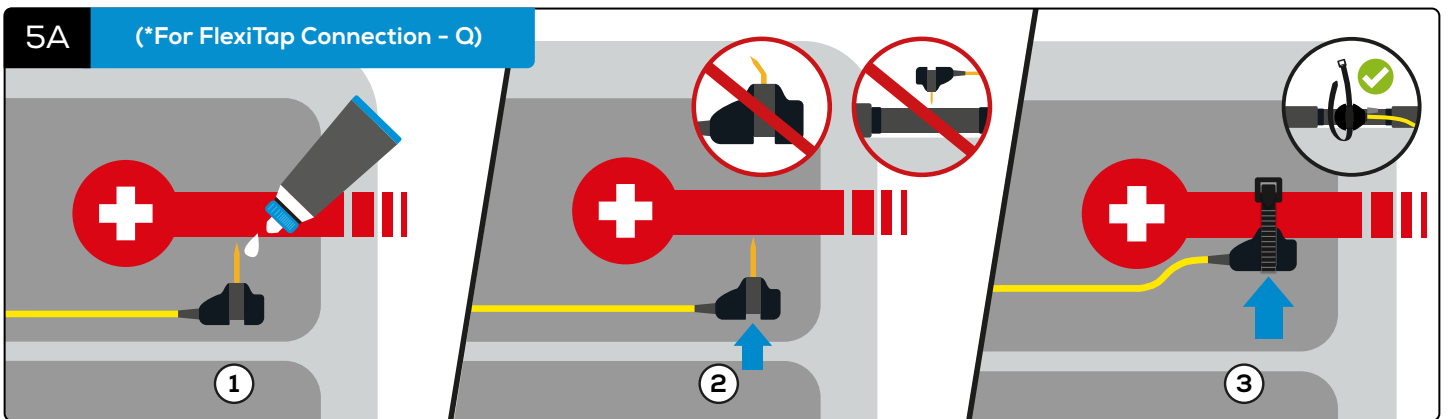

5A (*For FlexiTap Connection - Q)
Apply the grease on the pin. Insert the FlexiTap into the centre of the cable from the side, to ensure a good connection and secure it with a cable tie.
***Make sure it is positioned in the centre of the cable from the side, taking care not to bend the pin.**

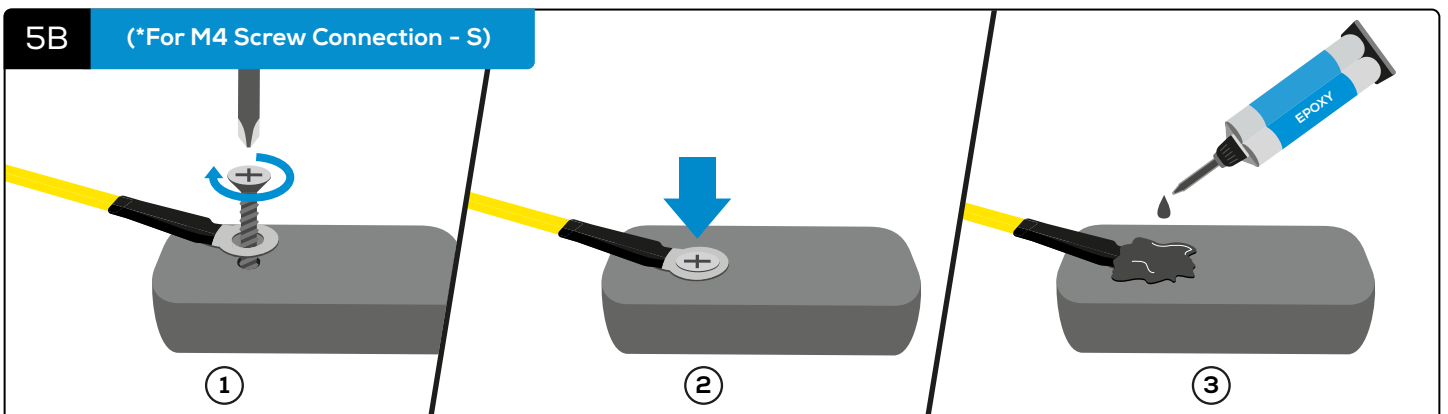

5B (*For M4 Screw Connection - S)
Screw the M4 connection to the terminal, make sure it is firmly attached to the battery. And apply epoxy on top of the screw.

SECTION 3B: INSTALLATION - VRLA BATTERIES (CONT'D)

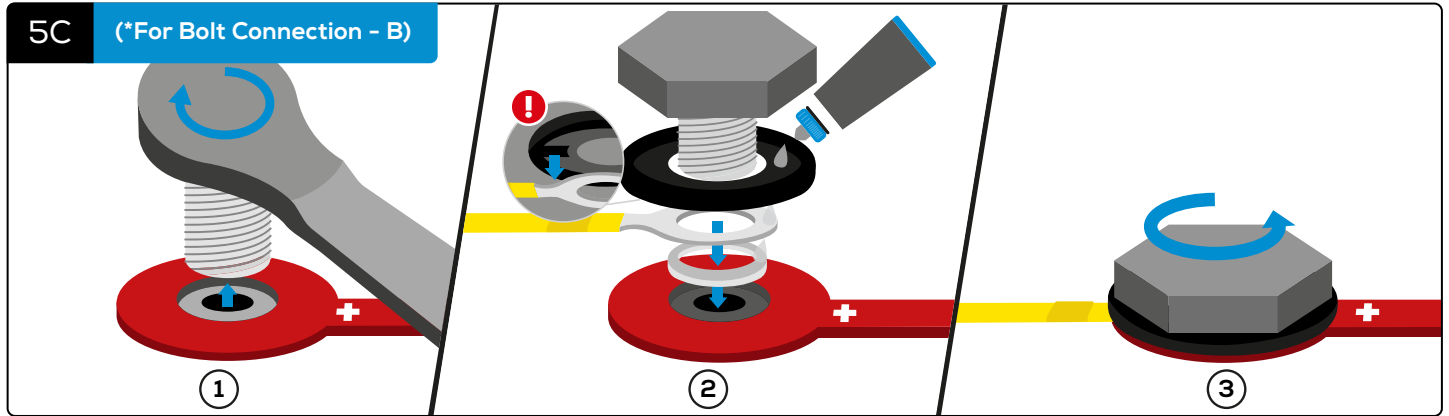

Remove the terminal bolt. Apply a thin layer of grease to the washer, the ring of bolt connection and the rubber gasket, then place them in the corresponding order. Ensure the bolt connection align to the rubber gasket and it is firmly attached to the terminal.

(*Note: Tighten the bolt to manufacturer-recommended torque settings.)

INITIAL START UP

Once the power connections have been made and the current clamp installed, the eGO!Plus is ready to start monitoring. Once the positive and negative connections have been made you should expect to see the following light sequence:

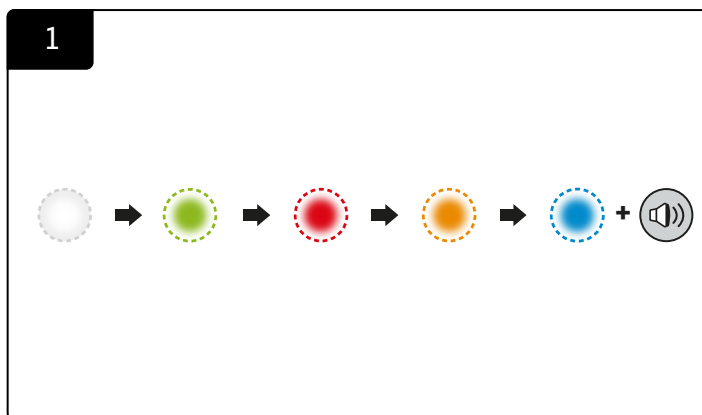

Starting main application.



Internal storage initializing.

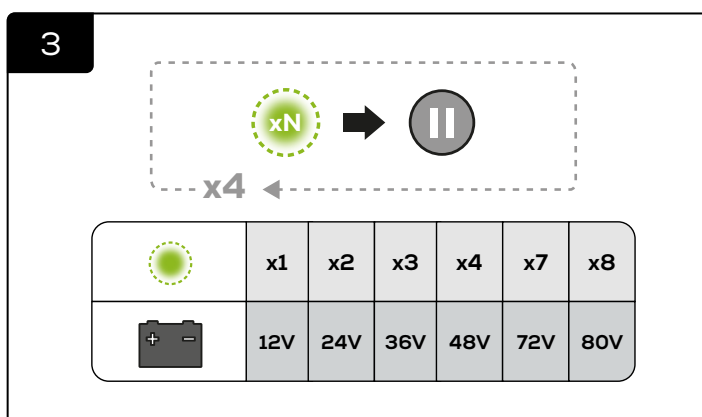

A number of green flashes followed by a pause is repeated four times. The flashes indicate different battery voltages detected. (*For LED indications, please refer to [Figure 4.](#))

SECTION 3B: INSTALLATION - VRLA BATTERIES (CONT'D)

AUTOMATIC UPLOAD

When the battery is fully charged, the eGO!Plus will automatically trigger upload and will start flashing blue for 20 seconds. If there is an internet connected eGO!CloudLink installed in the battery room, it will send the data to batterymanagement.net

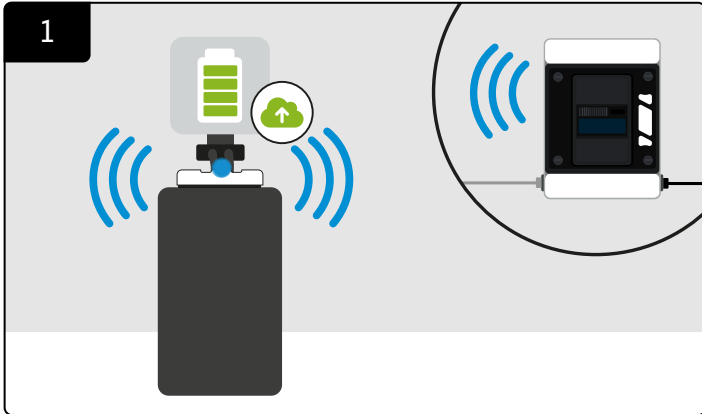

The blue LED will start flashing to indicate an automatic data upload via eGO!CloudLink to batterymanagement.net when the battery is fully charged.



When the upload is completed, eGO!Plus will return to its normal state of flashing green.

The eGO! Data is now available on batterymanagement.net.

MANUAL UPLOAD

eGO! data is accessible at any time, even when the battery is not fully charged. You can trigger data uploads using the CloudLink feature in the eGO!Tools app.

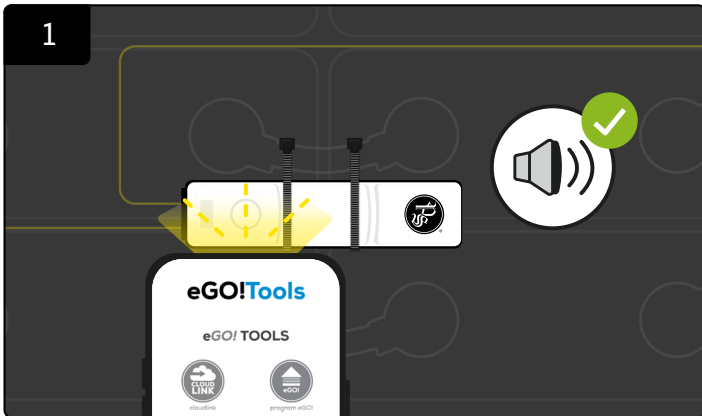

Click 'CloudLink' in the eGO!Tools app.

Take a bright flash light (*A mobile phone flash light will be adequate) and place directly on **top of the white circle on eGO!Plus**, until you hear a beep along with blue LED.

(*Note: A flash light may not work under very bright sunlight. You must shade the unit for at least 5 seconds, then use the light source to activate the manual upload.)

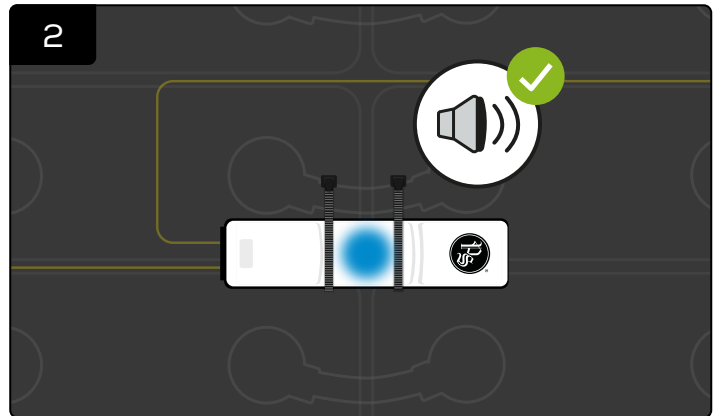

At this point quickly remove the flash light and you should hear a second beep.

*If the second beep is not heard, then the sequence will need repeating, allowing for a 3-second reset period before the next attempt.

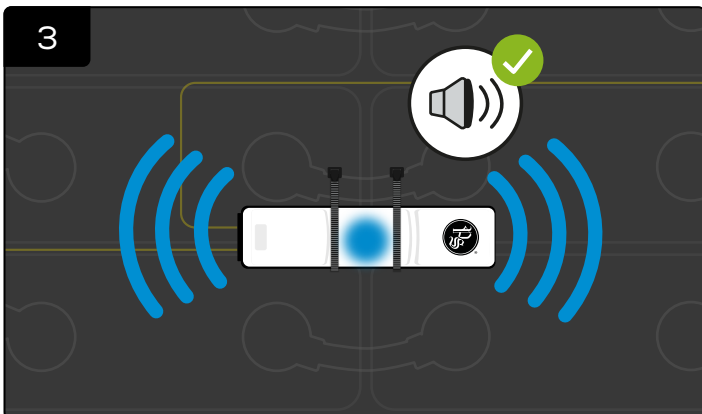

The radio is now enabled, and the blue LED remains illuminated until all data has been transmitted.

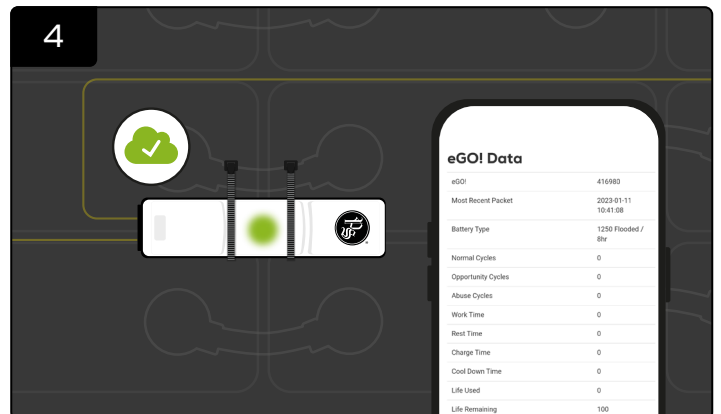

When the upload is completed, eGO!Plus will return to its normal state of flashing green. The eGO! Data is now available in eGO!Tools app.

SECTION 4: VISUAL LED & AUDIO ALARM INDICATIONS

Figure 3: LED & alarm indications for **flooded battery applications**

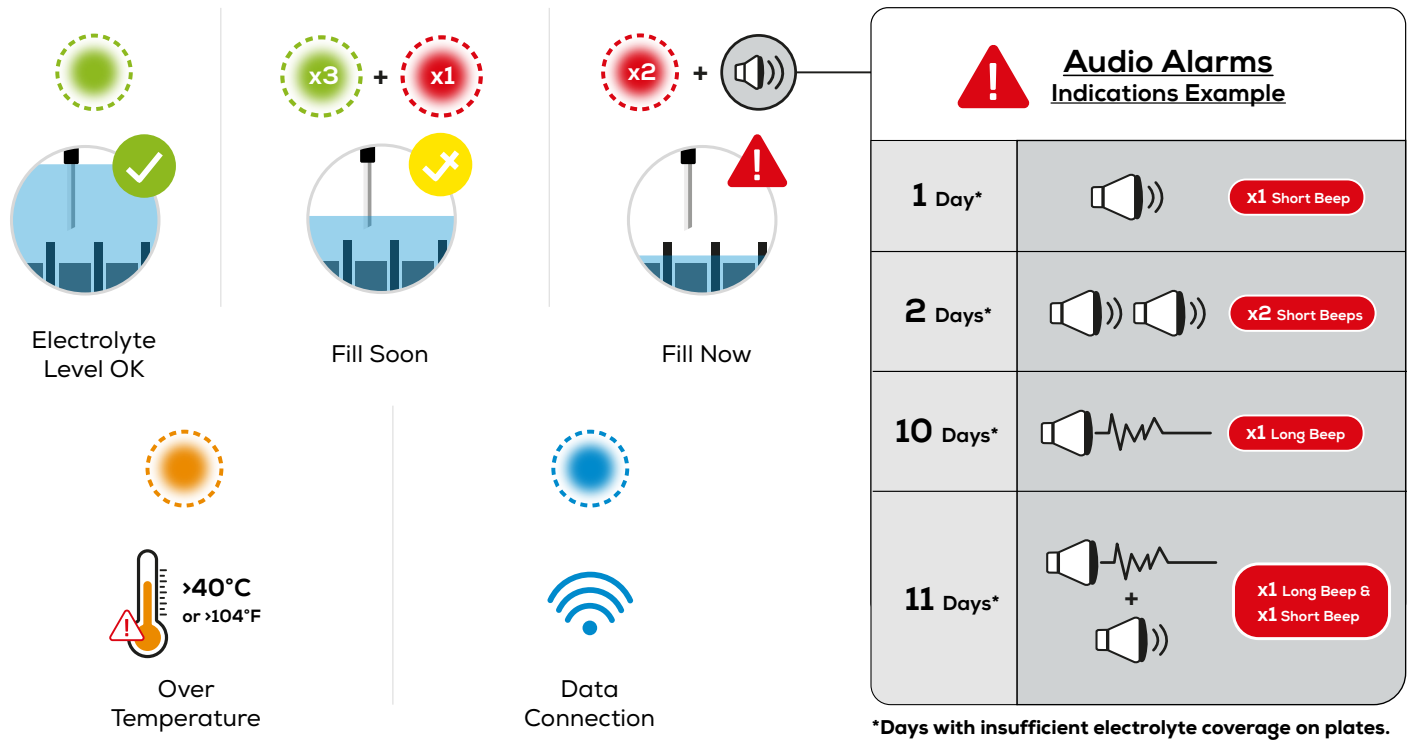

*If the White LED illuminates, please contact your local supplier.

Figure 4: LED Indications for **vrla battery applications**

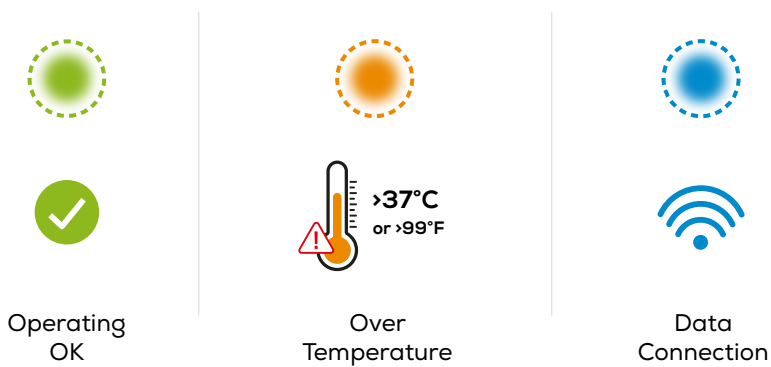

*If the White LED illuminates, please contact your local supplier.

EGO!RECEIVER™

iHUB-EGO-RK

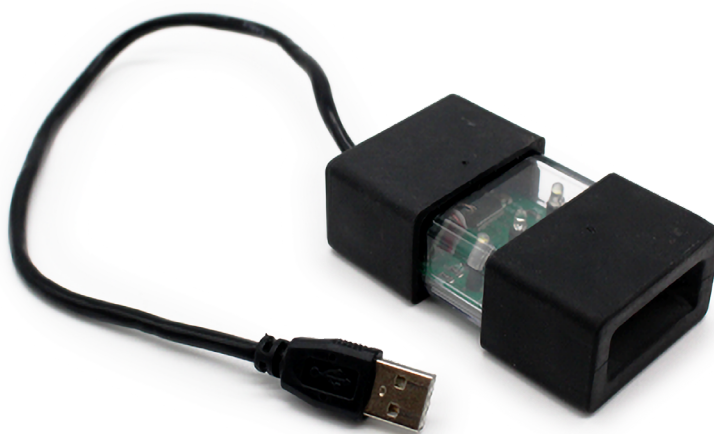

The eGO!Receiver collects eGO! data packets when connected to the eGO!Tools web app on a PC. This connection removes internet limitations on-site, allowing offline data uploads via the eGO!Receiver to BatteryManagement.net.

Through the online portal BatteryManagement.net, users can easily access a comprehensive view of a battery's life cycle. The extensive data collected from each battery cycle allows for in-depth analysis of battery performance and behaviour.

SECTION 5B: CONNECTIVITY - EGO!RECEIVER (CONT'D)

OVERVIEW OF DATA UPLOAD PROCESS

Figure 5: Data upload process via eGO!Receiver™ to batterymanagement.net



STEP 1: DOWNLOAD DATA FROM EGO!

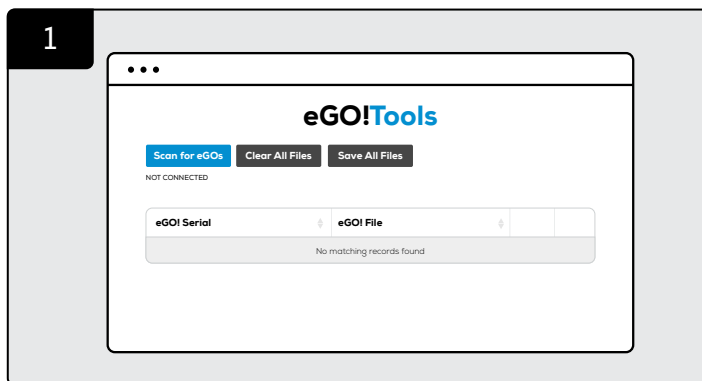

Go to eGO!Tools webpage:
<https://batterymanagement.net/egotools>
OR open the eGO!Tools app on your PC (for offline use).

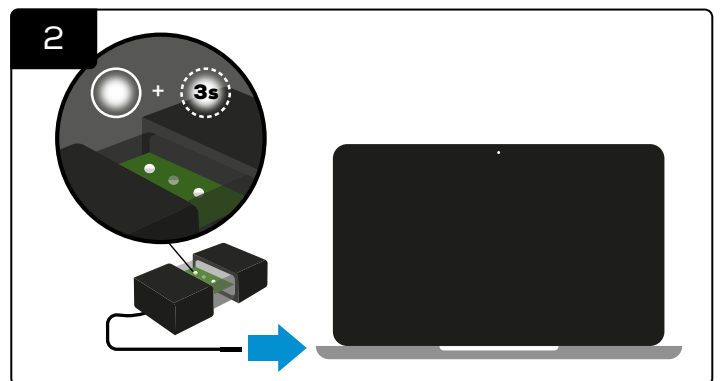

Connect eGO!Receiver to your PC.
***If it connects successfully, the LED on eGO!Receiver will illuminate with one solid white LED and one flash white for 3 seconds.**

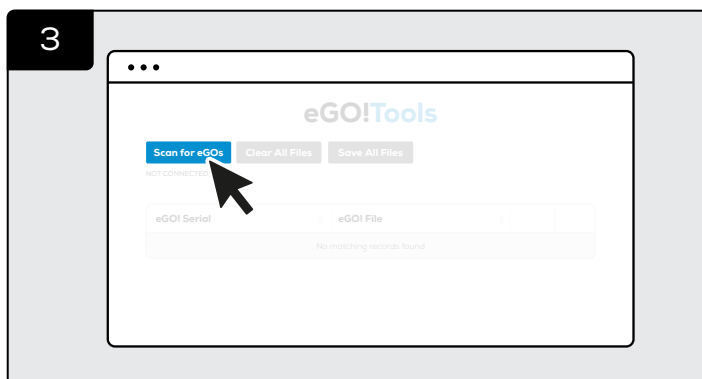

When the two white LEDs on eGO!Receiver illuminate, click '**Scan for eGOs**', then **select eGOs serial port**.



If the flashing white LED becomes solid (2 solid white LEDs), the eGO!Receiver is successfully connected to the eGOs serial port.

SECTION 5B: CONNECTIVITY - EGO!RECEIVER (CONT'D)

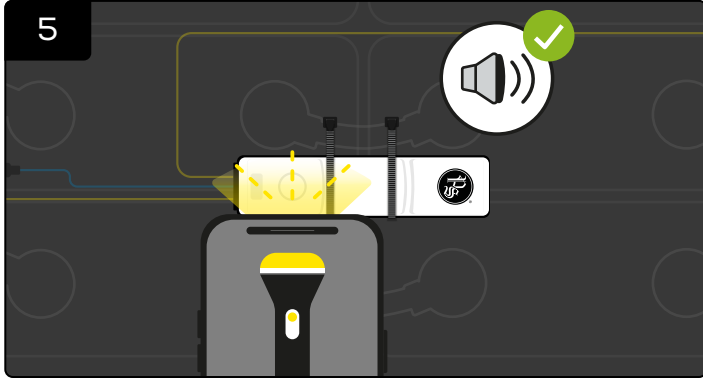

Take a bright flash light (*A mobile phone flash light will be adequate) and place directly on **top of the white circle on eGO!** until you hear a beep along with blue LED.

(*Note: A flash light may not work under very bright sunlight. You must shade the unit for at least 5 seconds, then use the light source to activate the manual upload.)

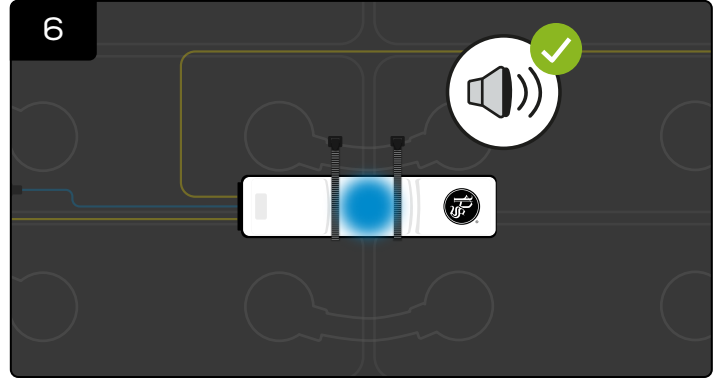

At this point quickly remove the flash light and you should hear a second beep.

*If the second beep is not heard, then the sequence will need repeating, allowing for a 3-second reset period before the next attempt.

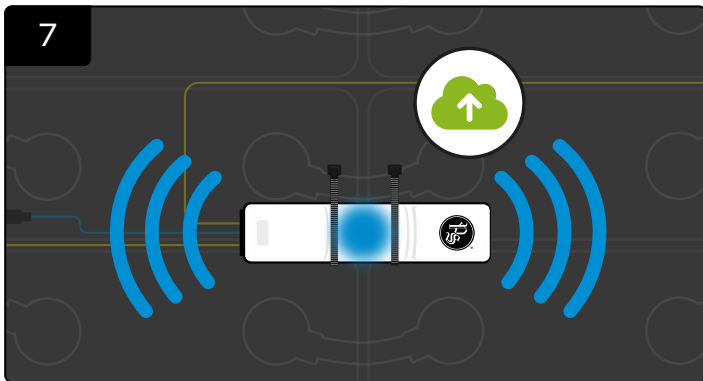

The radio is now enabled, and the blue LED remains illuminated until all data has been transmitted.

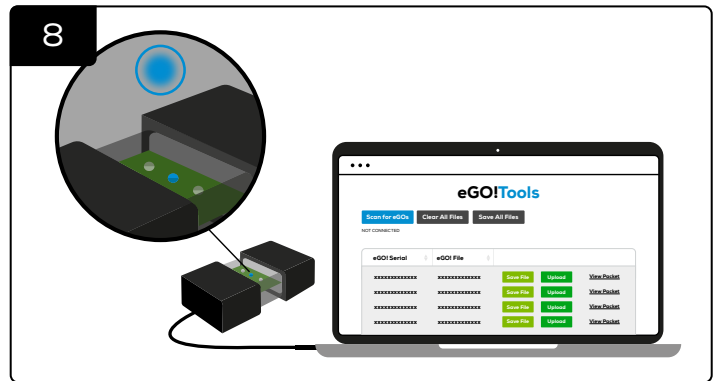

If data uploads successfully to eGO!Tools, blue LED will also illuminate on eGO!Receiver. eGO! data packets will appear in the list, along with the voltage logs.

STEP 2: SAVE DATA VIA EGO!TOOLS

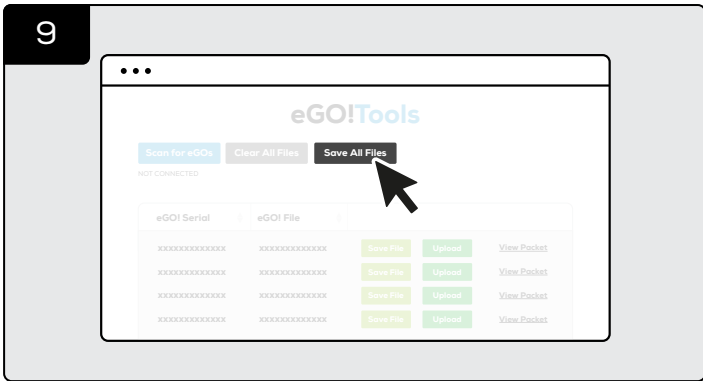

Click 'Save All Files' on eGO!Tools.

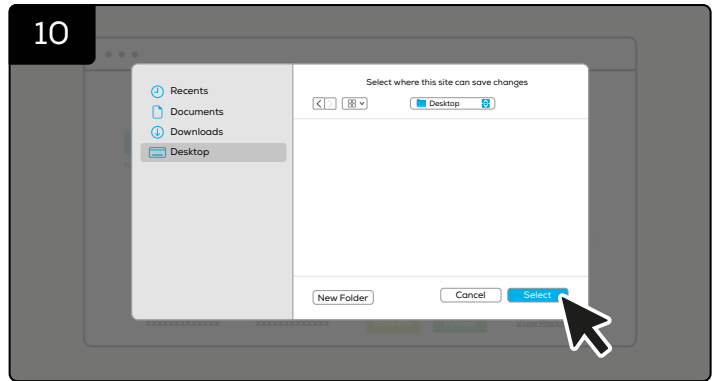

Save the files to your PC.

STEP 3: UPLOAD DATA TO BATTERYMANAGEMENT.NET

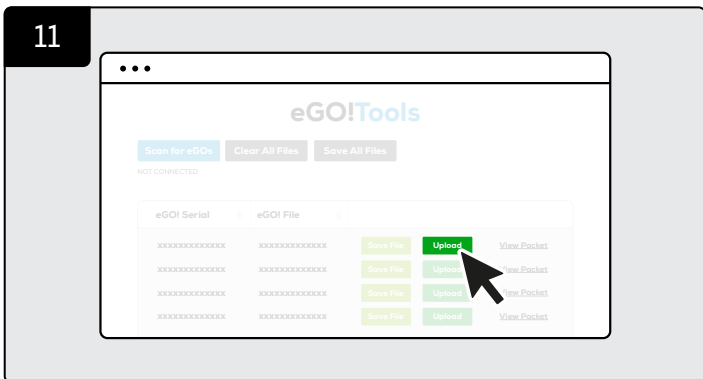

Click 'Upload' on eGO!Tools.

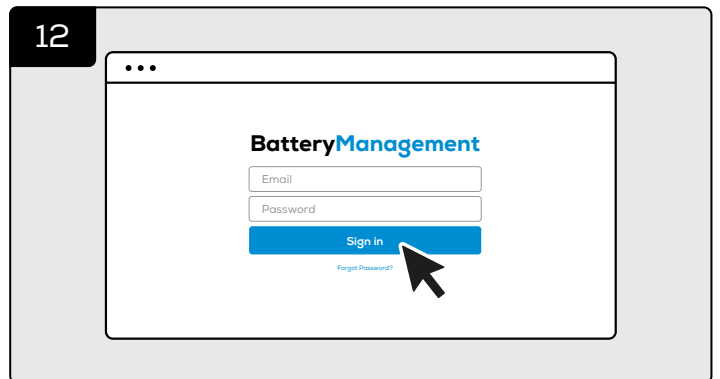

You will be directed to batterymanagement.net Login with your account details.

SECTION 5B: CONNECTIVITY - EGO!RECEIVER (CONT'D)

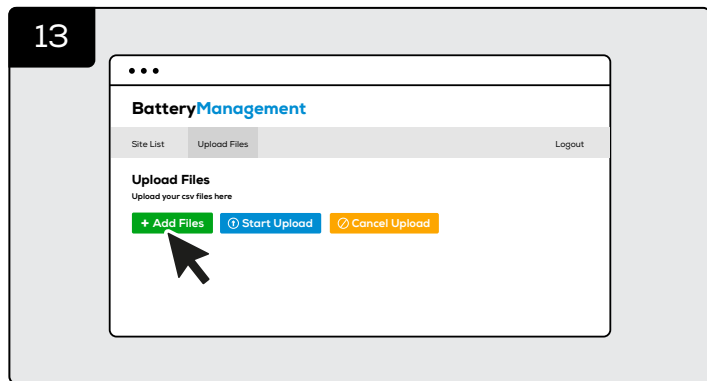

Click '+ Add Files'.

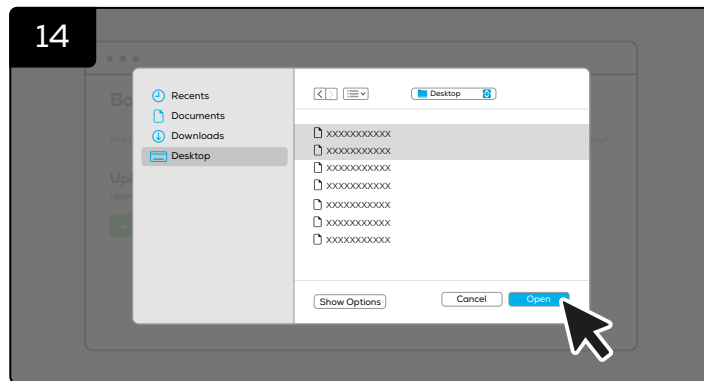

Select all downloaded files from your PC.
All data is now able to access online via batterymanagement.net.

FOR OFFLINE USE: DOWNLOAD EGO!TOOLS™ APP ON DESKTOP

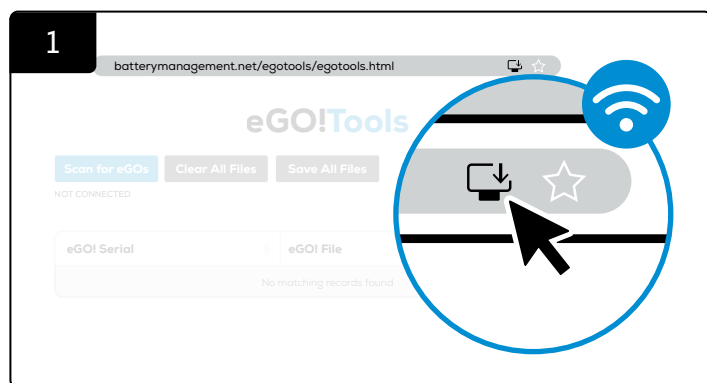

Go to eGO!Tools webpage:
<https://batterymanagement.net/egotools>
Download the web app - eGO!Tools to your desktop
when you have online connection.

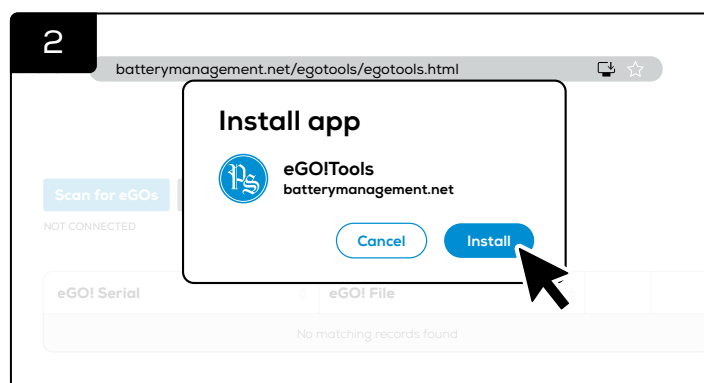

You will be asked if you wish to install the eGO!Tools app.
Download it to your desktop.

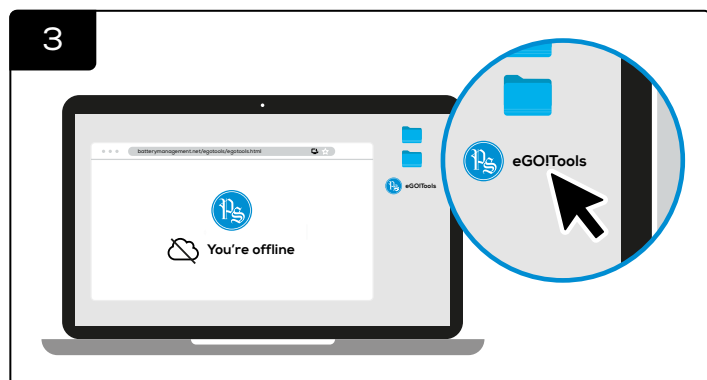

The app will appear as an icon on your desktop.

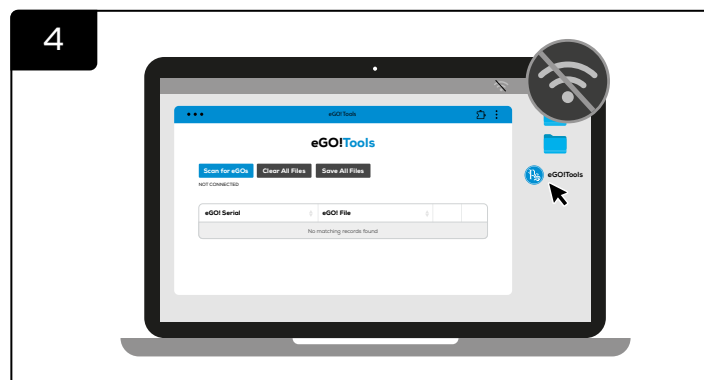

It can be used offline to download data from eGOs.

EGO!CLOUDLINK™

iHUB-CL1 (Ethernet)
iHUB-CL2 (WiFi)



The eGO!Cloudlink receives eGO!Plus data packets when they are manually or automatically broadcast. This creates a comprehensive picture of a battery's life as the volume of data from every battery cycle is considerable and enables deep analysis of the battery behaviour.

If the eGO!Cloudlink is connected to the internet it automatically uploads the data it has received to the correct organisation in www.batterymangement.net for immediate viewing, if email alerts have been assigned to the site they will be initiated based on the pre-set parameters.

When the eGO!Cloudlink does not have an internet connection the data is stored locally on a USB drive to be uploaded when it is connected or to be copy and pasted into eGO!Tools for sending.

SECTION 5A: CONNECTIVITY - EGO!CLOUDLINK (CONT'D)

TOOLS REQUIRED

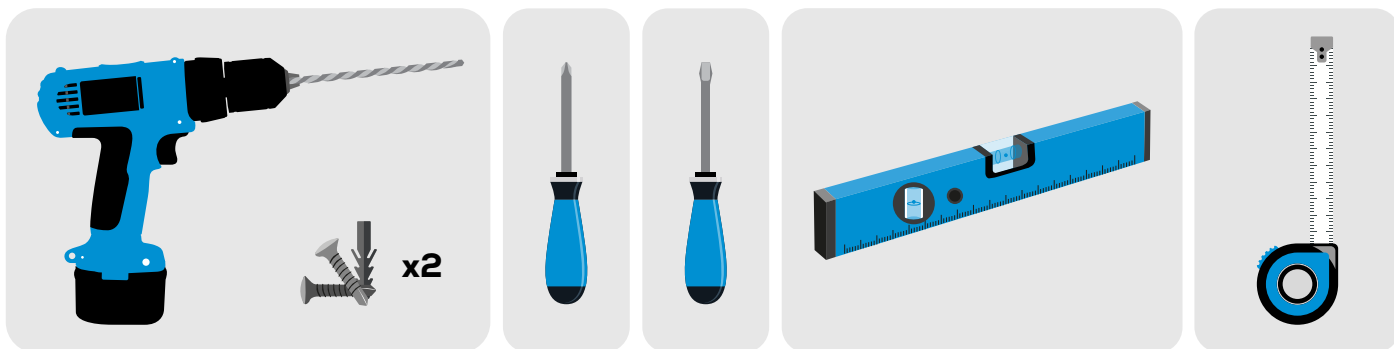

EGO!CLOUDLINK INSTALLATION

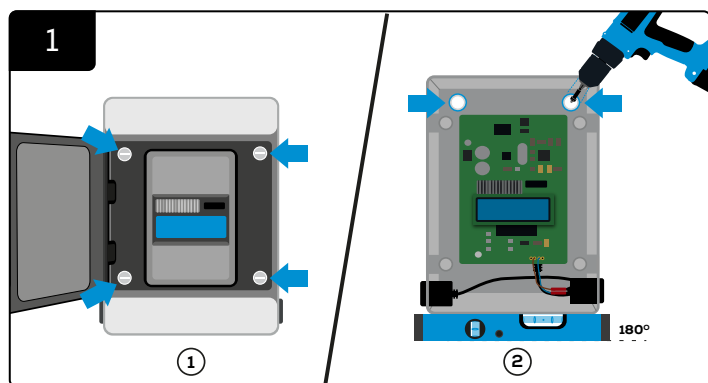

Open and unscrew the grey cover. Mount the control box to the wall using four screws/anchors and a level. Make sure it is firmly attached to the wall. Rescrew the cover.

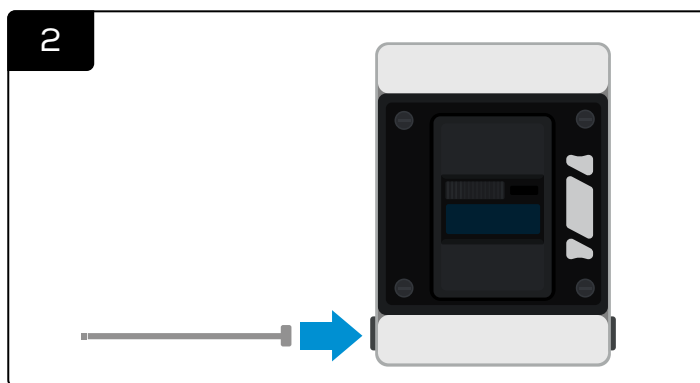

Connect the data cable to the eGO!Cloudlink.

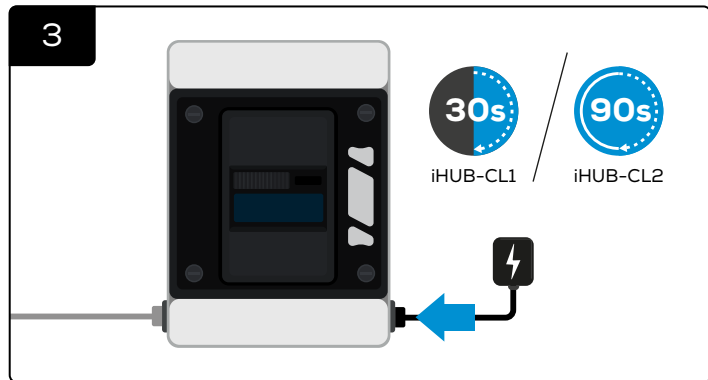

Connect the eGO!CloudLink with power connection. And wait for 30 seconds for iHUB-CL1; 90 seconds for iHUB-CL2.

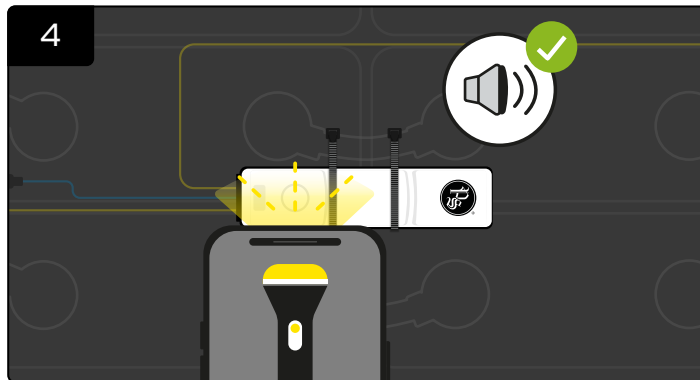

Take a bright flash light (*A mobile phone flash light will be adequate) and place directly on **top of the white circle on eGO!** until you hear a beep along with blue LED.
(*Note: A flash light may not work under very bright sunlight. You must shade the unit for at least 5 seconds, then use the light source to activate the manual upload.)

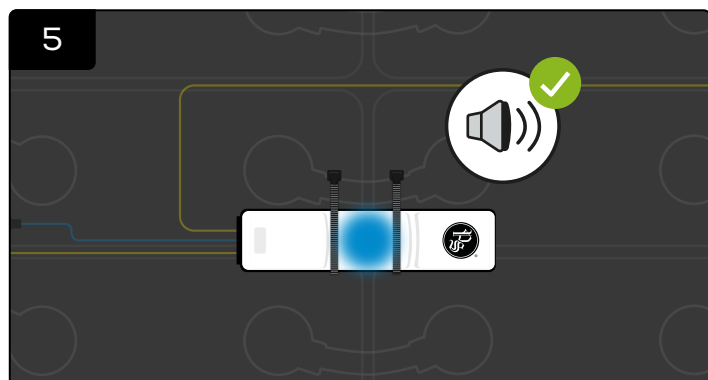

At this point quickly remove the flash light and you should hear a second beep.
*If the second beep is not heard, then the sequence will need repeating, allowing for a 3-second reset period before the next attempt.

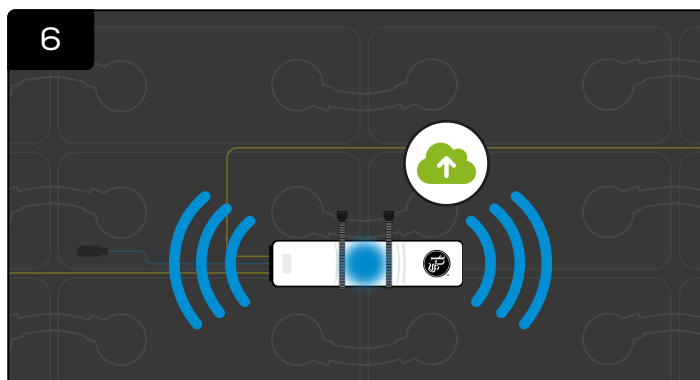

The radio is now enabled, and the blue LED remains illuminated until all data has been transmitted to eGO!CloudLink.

SECTION 5A: CONNECTIVITY - EGO!CLOUDLINK (CONT'D)

FOR iHUB-CL1 (Wired): ASSIGNING A STATIC IP ADDRESS

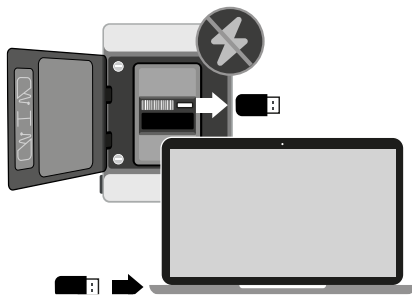

Step 1

Eject the eGO!CloudLink memory stick and insert it into a PC.



Step 2

Open the eGO!CloudLink folder. Look for the '**networkconf.txt**' file. Replace DHCP with the IP address (e.g. 192.168.0.123). Then save the txt file.

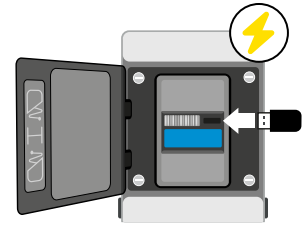

Step 3

Re-insert the memory stick into the eGO!CloudLink.

FOR iHUB-CL2 (WiFi): CONFIGURING A WIFI CONNECTION

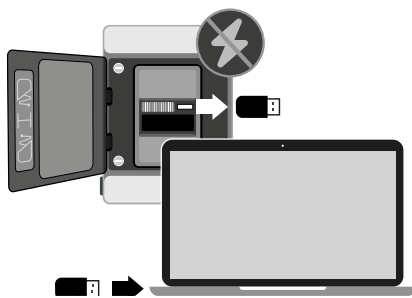

Step 1

Eject the eGO!CloudLink memory stick and insert it into a PC.



Step 2

Open the eGO!CloudLink folder. And edit the '**networkconf.txt**' file with the information below. Then save the txt file.

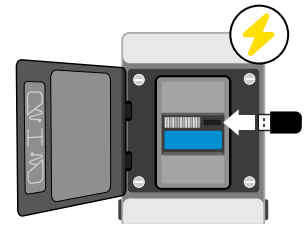

Step 3

Re-insert the memory stick into the eGO!CloudLink.

The eGO!CloudLink can connect to a visible wifi network either **with DHCP** or **with static network settings**.

With DHCP Settings

To set the eGO!CloudLink to connect to a visible SSID with DHCP, the networkconf.txt file must contain the following information:

IP =
Netmask =
Gateway =
Wifi SSID = **(Your Wifi Network ID)**
Wifi Password = **(Your Wifi Network Password)**
Wifi IP =
Wifi Netmask =
Wifi Gateway =

With Static Network Settings

To set the eGO!CloudLink to connect via Wifi using static network settings, the networkconf.txt file must contain the following information:

IP =
Netmask =
Gateway =
Wifi SSID = **(Your Wifi Network SSID)**
Wifi Password = **(Your Wifi Password)**
Wifi IP = **(Your Wifi Network IP, e.g. 192.168.0.100)**
Wifi Netmask = **(Your Wifi Netmask, e.g. 255.255.255.0)**
Wifi Gateway = **(Your Wifi Gateway, e.g. 192.168.0.1)**

EGO!GATEWAY™

iHUB-CLA-02 (WiFi)



The eGO!Gateway™ Battery Data Transmitter automatically collects the data from any eGO!™ Battery Performance Monitors that are within range and uploads the data directly to the online portal. This data is available in real-time and shows the status of the connected devices.

SECTION 5C: CONNECTIVITY - EGO!GATEWAY (CONT'D)

TOOLS REQUIRED

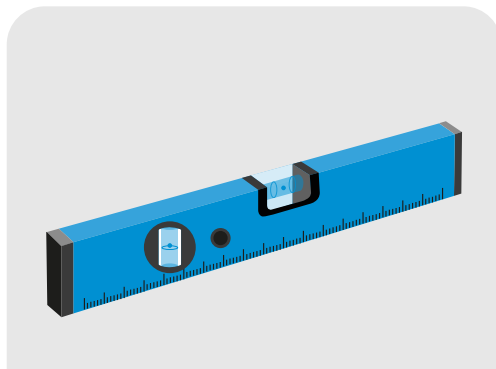
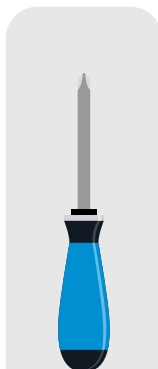

EGO!GATEWAY INSTALLATION

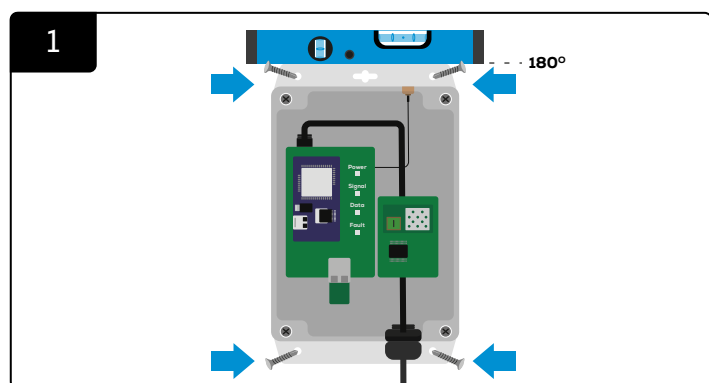

Mount the control box to the wall using four screws/anchors and a level. Make sure it is firmly attached to the wall.

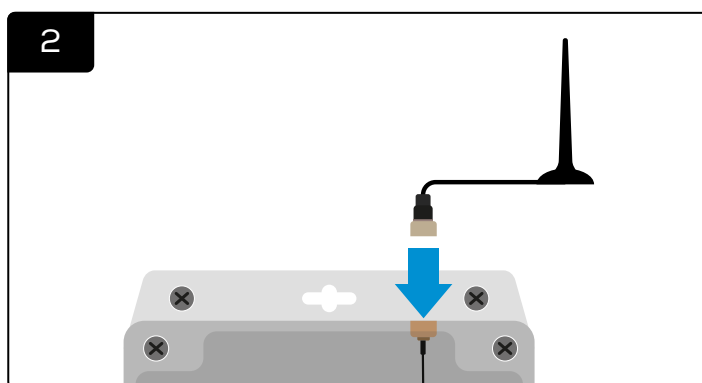

Attach antenna to the eGO!Gateway™.

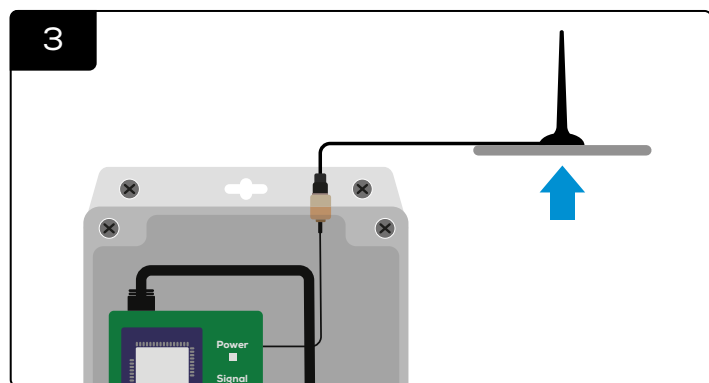

Place the antenna as high as possible to maximise signal.

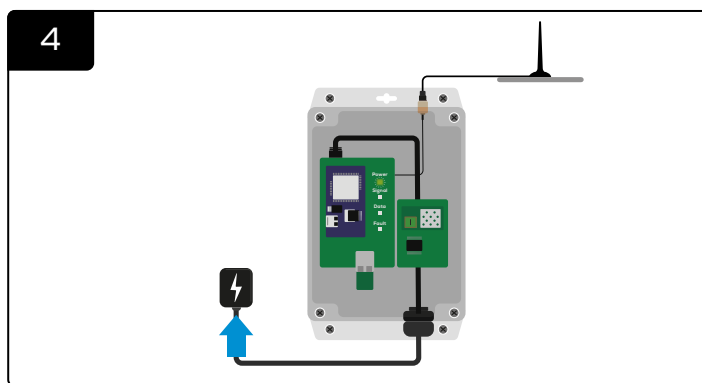

Powering the device.

SECTION 5C: CONNECTIVITY - EGO!GATEWAY (CONT'D)

START-UP LED SEQUENCE

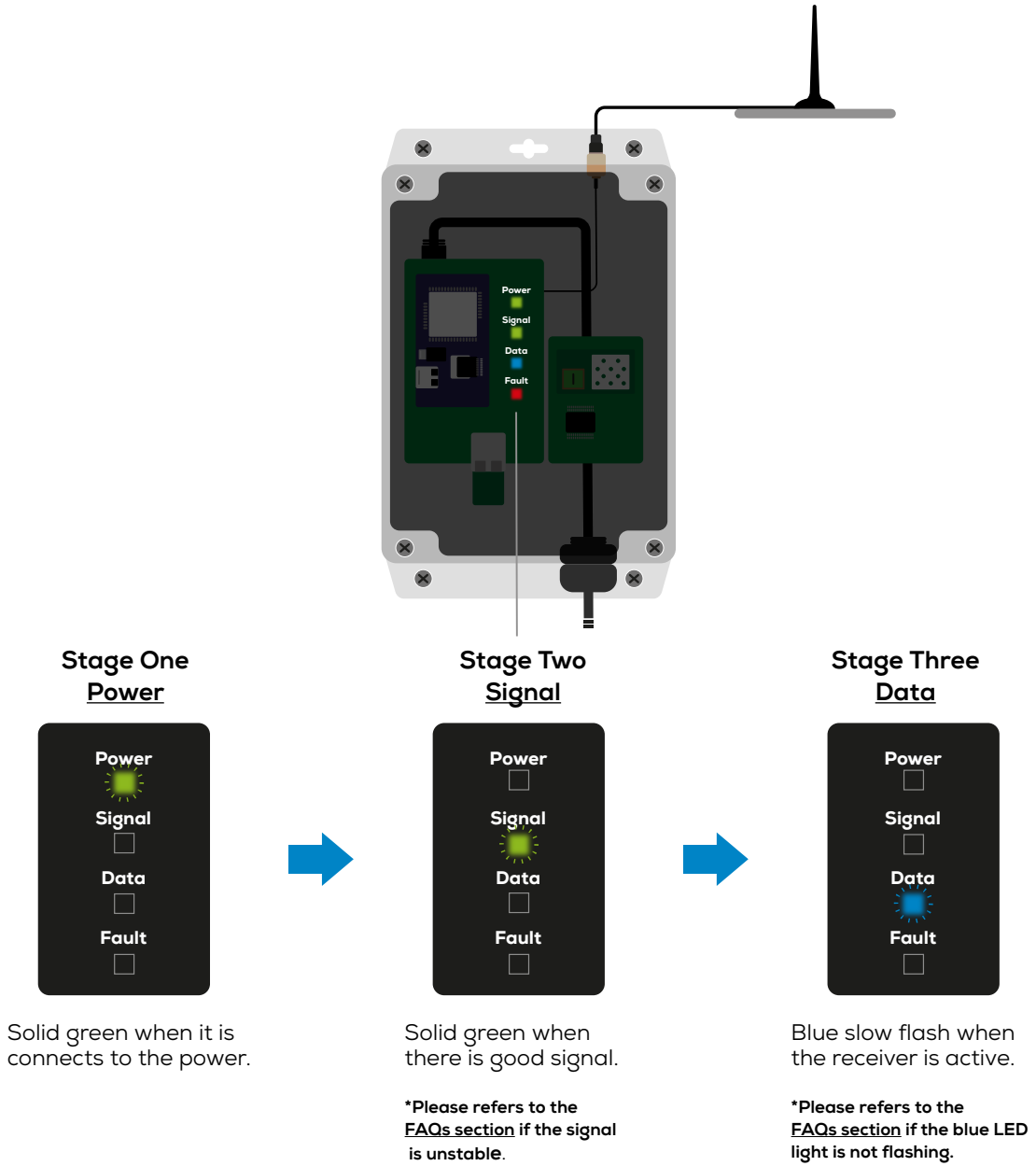

*If the Red LED illuminates, please contact your local supplier.

Table 2: Installation Locations

✔ Recommend Locations	✖ Avoid Locations
Battery Room	Exterior Location
Main Charging Area	Humid Areas (e.g. Boiler Room)
Central Location	Enclosed Spaces
Central Doorway	Metal Clad Areas

SECTION 6: FREQUENTLY ASK QUESTIONS (FAQS)

EGO!™ - BATTERY PERFORMANCE MONITOR

- Q1** **How is opportunity charging configured in the eGO! Data?**
Opportunity charging is a fact of life in the battery world. If done too frequently it can reduce the life expectancy and performance of the battery due to acid stratification and cell imbalances. At the end of any normal charge profile a battery is subjected to higher voltages than it can sustain. The surplus energy turns some of the water in the cell into hydrogen and oxygen bubbles which rapidly travel to the surface, mixing the electrolyte as they go. The eGO! monitors opportunity charging by recording the time the battery has spent on charge without going through a recognised termination charge profile. By comparing the amount of opportunity charge time against the known full charge time of the charger we can calculate the proportional amount of a cycle used during opportunity charging. In simple terms, if it normally takes 8 hours for a complete charge, 1 opportunity charge cycle will be debited for every 8 hours of opportunity charging accumulated. The default battery type charge time is 8 hours however if the charge time is different then a specific battery type can be applied to that eGO!, please follow the instructions for creating new battery types or speak to Philadelphia Scientific.
- Q2** **What determines an abuse cycle in the eGO! Data?**
Lead-acid batteries are robust and dependable energy storage devices. They are usually designed to perform at the same level for at least 1250 cycles when operated within specific parameters. Occasional instances of abuse will not kill an industrial lead acid battery, but chronic abuse will reduce the life expectancy severely. Abuse is in the form of high temperatures, over discharge and low electrolyte levels. The impact of these factors on batteries has been documented by ZVEI (German Electro and Digital Industry) in several papers. The eGO! monitors abuse by recording all the time the battery has spent in all 3 abuse conditions. By comparing the amount of time in the abuse conditions against the amount of use the battery has had in operation, it calculates a percentage of additional degradation that has occurred to the battery. This abuse value is converted to cycles in order that it can be deducted from the overall battery life expectancy. As a rough guide; for each cycle determined to be in an abuse condition there is one penalty cycle deducted from the estimated battery life.
- Q3** **What is meant by cool down time in the eGO! Data?**
Cool down time is the amount of time between charger termination and the battery disconnection from the charger. Cool down time is simply the time the battery spent cooling down after a charge.
- Q4** **What is meant by rest time in the eGO! Data?**
Rest time occurs in the discharge phase – when the battery has been disconnected from the charger and is being used. There are many periods of work, when the battery is being discharged and the voltage is fluctuating, and rest, when the battery is not being used and the voltage is stable. The total rest time for a cycle is the total amount of time spent in rest – i.e. all of these rest periods added up together.
- Q5** **How is stratification determined?**
Stratification is when the acid sinks and water rises to the top of the cell, it can be seen by an abnormally high surface voltage at the start of the discharge. When the eGO! monitors the voltage above the normal open circuit level, but below the charge threshold, for more than 10 minutes it determines the battery to be stratified.
- Q6** **What is the operating temperature range of the eGO! ?**
-28 to 55°C
- Q7** **When is the end of a normal charge?**
A normal charge is determined by the battery attaining gassing threshold, typically 2.4vpc. This means that the battery has been through all phases of charge.
- Q8** **What are the parameters for abuse cycles?**
Abuse is determined as;
 - Low electrolyte - the electrolyte level being below the bottom of the electrolyte probe. This is time compensated for the distance from the probe to the battery plates and electrolyte level fluctuation.
 - Over temperature - temperature of the battery being over 40°C.
 - Over discharge - battery is discharged below 80% of capacity.

SECTION 6: FREQUENTLY ASK QUESTIONS (FAQS) (CONT'D)

EGO!™ - BATTERY PERFORMANCE MONITOR

Q9

What are the different definitions of cycles?

- Normal Charge Cycles = Number of cycles of a discharge followed by a full charge.
- Estimated Cycles = Normal Charge Cycles + Opportunity Cycles.
- Combined Cycles = Estimated Cycles + Abuse Cycles.

Q10

Is the data available for every cycle?

The eGO! records data accumulated over the long term. It provides data as totals, maximums, minimums and averages over the time the battery has been in use and monitored. It is a battery life history monitor that provides essential information so that owners and operators can understand how the battery is performing and being operated. If you also require minute by minute logs of the battery data this is available with the eGO!Pro.

Q11

Is it possible to get the voltage of individual cells?

To monitor the voltage of individual cells, then each cell would need a voltage connection. This would mean an extremely complicated and expensive monitor in the class of full battery diagnostic tools. The eGO! is made to a price point to be accessible for all battery operations and is market leading in terms of price versus functionality and data.

Q12

What is the default battery type in the eGO! Data?

The default battery is based on a flooded 1250 cycle battery and an 8 hour charger. For variations on the default battery type simply create a new battery in the BatteryManagement.net website and assign it to the battery when the eGO! is approved. The battery cycle life, charge hours and penalties can be changed, however we recommend you consult Philadelphia Scientific prior to changing penalties. Different battery types can be created to assist with sorting and searching the data, for example a 1500 cycle reach truck battery can be created as a specific battery type in BatteryManagement.net.

EGO!GATEWAY™

Q1

The signal LED does not turn solid green.

This means that the signal is insufficient. Transfer the gateway to a location where the signal is better.

Q2

There is a solid red LED on the gateway – what does this mean?

A solid red led means the gateway is faulty. Please contact your local supplier.

Q3

I've powered up the gateway, but none of the LEDs are turning on.

Check the plug is correctly connected and turned on. If the problem persists contact your local supplier.

Q4

The blue LED is not flashing – what does this mean?

This means the receiver has not activated and data is not being uploaded. Please contact your local supplier.



**FOR PRODUCT SPECIFICATIONS, USER GUIDES
AND FURTHER INFORMATION PLEASE VISIT:**

<https://www.phlsci.com/product-lines/battery-performance-monitors/>

DOC0625© 2025 Philadelphia Scientific UK Ltd. All Rights Reserved. Philadelphia Scientific and the PS logo are registered trademarks of Philadelphia Scientific LLC. eGO!, eGO!Plus and eGO!CloudLink are trademarks of Philadelphia Scientific UK Limited. E&O.E. R3-040325



WWW.PHLSCI.COM

Philadelphia Scientific LLC
P: +1 (215) 616 0390
E: info@phlsci.com

Philadelphia Scientific EMEA
P: +44 (0) 1204 467777
E: info@phlsci.co.uk

Philadelphia Scientific ASIA PACIFIC
P: +61 (2) 8004 2447
E: info@phlsci.com.au

